



# **GAS METER BOX LOCATION HANDBOOK (FOR GAS METER SIZES AL8 TO AL18)**

---

**GAS DIVISION**

Document No: AGA-A&C-MA03  
Revision No: 10  
Issue Date: 10/02/2020

# Contents

<b>1.</b>	<b>INTRODUCTION .....</b>	<b>1</b>
1.1	GLOSSARY.....	2
1.2	CONTACT INFORMATION.....	2
<b>2.</b>	<b>INSTALLATION RESPONSIBILITIES .....</b>	<b>3</b>
2.1	REQUIREMENTS OF THE “RESPONSIBLE PERSON”.....	3
2.2	AVOIDING DELAYS IN GAS SERVICE INSTALLATION .....	3
2.3	INTERNAL PROPERTY REINSTATEMENT .....	4
<b>3.</b>	<b>CONNECTING TO THE GAS NETWORK .....</b>	<b>5</b>
3.1	CONNECTION PROCESS.....	5
3.1.1	Single Residential House .....	5
3.1.2	Multi-unit Connection Process.....	5
3.1.3	Commercial Gas Connections .....	5
3.2	DETERMINING GAS AVAILABILITY .....	5
3.3	GAS METER SIZE AND DIVERSIFICATION.....	6
3.4	ACCESSIBILITY.....	7
3.4.1	Mandatory Lock Requirements.....	7
3.4.2	Viewing Apertures for Locked Enclosures.....	8
3.5	SERVICE CONNECTION .....	8
3.5.1	Connection without Pre-laid Service ( <b>PLS</b> ).....	8
3.5.2	Connection to Pre-laid Services ( <b>PLS</b> and <b>PLSS</b> ).....	9
3.5.3	Service Sleeve/Conduit (Retaining walls, Elevated lots).....	11
3.5.4	Designated Boundary Connection Areas .....	12
3.5.5	Gas Services to Large Rural or Semi-rural Lots .....	12
3.5.6	Connection to Commercial Properties (AL8, AL10, AL12, AL18 Gas Meters) .....	13
<b>4.</b>	<b>GAS METER BOX LOCATIONS.....</b>	<b>14</b>
4.1	GAS METER LOCATION – EXAMPLES.....	14
4.1.1	Standard House.....	15
4.1.2	Rear Laneway ( <b>Must</b> Determine Gas Availability) .....	16
4.1.3	Pre-laid at Top of Stairs/Retaining Wall.....	18
4.1.4	Service Separation Requirements.....	19
4.1.5	Carport .....	21
4.1.6	Elevated Lot with Retaining Walls.....	23
4.1.7	Tiered or Sloping Lots/Gardens (or equivalent lower lots).....	24
4.1.8	Retained Garden Beds .....	24
4.1.9	House with Swimming Pool .....	26
4.1.10	Property without Street Frontage or Gas Availability (Access Easements) .....	26

4.2	LOCATION RESTRICTIONS - CONSUMER METER ASSEMBLIES (AS/NZS 4645.1 - 2018).....	28
4.3	OTHER GAS METER BOX LOCATION RESTRICTIONS.....	30
4.4	OBSTRUCTIONS (WHEN GAS METER BOXES CANNOT BE INSTALLED ON DWELLINGS) .....	31
<b>5.</b>	<b>GAS METER BOX INSTALLATION REQUIREMENTS.....</b>	<b>32</b>
5.1	GAS METER BOX DIMENSIONS (TYPICAL) .....	32
5.2	REQUIREMENTS .....	32
5.2.1	AL8/AL10/AL12/AL18 Gas Meter Box – Freestanding on Legs .....	32
5.2.2	AL8/AL10/AL12/AL18 Gas Meter Box – Freestanding on Pole .....	33
5.2.3	AL8/AL10 Gas Meter Box (Partially Recessed or Face-mounted) .....	34
5.2.4	AL12 Gas Meter Box (Partially Recessed or Face-mounted).....	34
5.2.5	AL8/AL10 Dual Gas and Electric Meter Box (Partially Recessed or Face-mounted).....	35
5.2.6	AL12 Dual Gas and Electric Meter Box (Partially Recessed or Face-mounted).....	36
5.2.7	Multi-unit Gas Meter Boxes (Partially Recessed or Face-mounted).....	37
5.2.8	Gas Meter Box (Fully Recessed).....	38
5.2.9	Partially Recessed Boxes (AL8/AL10/AL12).....	40
5.3	GAS METER BOX MOUNTED ON WALLS .....	41
5.3.1	Gas Meter Boxes on Nib Walls (Recommended Alternative Gas Meter Box Position) .....	41
5.3.2	Gas Meter Boxes on Freestanding Walls .....	41
5.3.3	Gas Service Riser and Footing Requirements .....	43
5.4	LOCATING A GAS METER BOX AWAY FROM OPENINGS INTO A BUILDING.....	44
5.4.1	Window within Gas Meter Box Exclusion Zone .....	46
5.4.2	Guidance for Measurements Around Corners to Openings .....	47
5.5	GAS METER BOXES MOUNTED ADJACENT TO ELECTRICAL POWER DOMES .....	48
5.6	GAS METER BOXES MOUNTED ADJACENT TO SOURCE OF IGNITION.....	49
5.7	PROTECTION FOR GAS METERS .....	51
5.7.1	L-bracket Requirements.....	52
5.7.2	Vehicle Wheel Stops ( <b>Domestic Dwellings Only</b> ) .....	52
<b>6.</b>	<b>GAS METER BANKS AND ENCLOSURES.....</b>	<b>53</b>
6.1	MULTI-UNIT GAS METER BOXES .....	53
6.2	BANKS OF GAS METER BOXES.....	54
6.3	BANKS OF GAS METERS MOUNTED ON ATCO APPROVED BRACKETS IN BUILDING RECESSES.....	56
6.3.1	Depth and Height of Recesses .....	57
6.3.2	Inside the Recess.....	57
6.4	GAS METERS IN RECESSES (ENCLOSURES) .....	58
6.5	DOORS AND VENTILATION.....	59
6.6	FLOOR FINISHES .....	60
6.7	SECURITY ACCESS.....	60

6.8	SIGNAGE .....	60
<b>7.</b>	<b>RELATED DOCUMENTS .....</b>	<b>61</b>
<b>8.</b>	<b>DISCLAIMER.....</b>	<b>62</b>
<b>9.</b>	<b>APPENDICES .....</b>	<b>63</b>
<b>APPENDIX A.</b>	<b>GAS CONNECTION CHECKLIST .....</b>	<b>64</b>
<b>APPENDIX B.</b>	<b>GAS SERVICE INSTALLATION ON HOLD FORM .....</b>	<b>66</b>
<b>APPENDIX C.</b>	<b>GAS SAFETY – DOS AND DON'TS .....</b>	<b>68</b>
<b>APPENDIX D.</b>	<b>FEEDBACK FORM – GMLH_RUDH .....</b>	<b>69</b>

## LIST OF FIGURES

Figure 1: Overview – Request for Gas .....	5
Figure 2: Gas Meter Box Viewing Aperture – Example.....	8
Figure 3: Plan Showing Gas Mains and Pre-laid Service Locations .....	9
Figure 4: Typical Connection to a Pre-laid Service.....	10
Figure 5: Stairways at Front of Properties .....	11
Figure 6: Pre-laid Gas Services Installed Under Stairways (PLSS) .....	11
Figure 7: Example Screen Shot – Designated Boundary Connection Area .....	12
Figure 8: Legend for Diagrams.....	14
Figure 9: Standard House .....	15
Figure 10: Laneway Example (Box on Boundary).....	16
Figure 11: Rear Laneway (Gas Available).....	17
Figure 12: Pre-laid at Top of Stairs (Double Stairway) .....	18
Figure 13: Pre-laid at Top of Stairs (Straight on Single Stairway) .....	19
Figure 14: Non-compliant Service Separation (Less than 150 mm between Utilities) .....	20
Figure 15: Minimum Utility Separation Distance Requirements (Gas Service Only) .....	20
Figure 16: Carport.....	21
Figure 17: Elevated Lot with Retaining Walls .....	23
Figure 18: Examples of Tiered or Sloping Lots/Gardens .....	24
Figure 19: Example of a Gas Meter Box Position Placed On Hold .....	25
Figure 20: House with Swimming Pool .....	26
Figure 21: Property without Street Frontage or Gas Availability.....	27
Figure 22: Non-compliant Service Separation (Less than 150 mm).....	30
Figure 23: Gas Meter Box Installed Above Flight of Stairs (Unacceptable Positions) .....	31
Figure 24: Gas Meter Box – Freestanding on Pole (Combination or Single).....	33
Figure 25: AL8/AL10 Gas Meter Box .....	34
Figure 26: AL12 Gas Meter Box .....	34
Figure 27: AL8/AL10 Dual Gas and Electric Meter Box .....	35
Figure 28: AL12 Combined Gas and Electric Meter Box .....	36
Figure 29: AL8/AL10 Double and Triple Gas Meter Box - Dimensions.....	37
Figure 30: AL8/AL10 Double and Triple Gas Meter Box .....	37
Figure 31: Gas Meter Box (Fully Recessed).....	38
Figure 32: Louvered Door Example for Fully Recessed Meter Box .....	39
Figure 33: Partially Recessed Boxes.....	40

Figure 34: Nib Wall (Example) .....	41
Figure 35: Freestanding Wall Housing Gas Meter Box ( <i>Example/Reference Only – Not for Construction Purposes</i> )	42
Figure 36: Footing Recess - Cut Out.....	44
Figure 37: Distances from Openings into the Building .....	45
Figure 38: Permanently Fixing Window within Exclusion Zone .....	46
Figure 39: Bay Window (Measure from the window opening to the meter box, in a straight line).....	47
Figure 40: Opening Around Corner (Measure from the closest opening, around the corner).....	47
Figure 41: Opening Around Closed Corner (Measure from the closest opening, in a straight line).....	48
Figure 42: Distances from Electrical Power Domes .....	48
Figure 43: Distances from Electrical Power Domes (Top view) .....	49
Figure 44: Distances from Electrical Power Domes (Side plan) .....	49
Figure 45: Separation from Potential Ignition Sources.....	50
Figure 46: Gas Meter Box Protection (Examples) .....	51
Figure 47: Gas Meter Box Protection (Bollard Diagrams).....	51
Figure 48: Gas Meter Box Protection (L-bracket Diagrams) .....	52
Figure 49: Vehicle Wheel Stops (Domestic Dwellings Only) .....	52
Figure 50: Double and Triple Gas Meter Boxes .....	53
Figure 51: AL8/AL10 Standard Gas Meter Bank Layout – Gas Meter Boxes.....	54
Figure 52: AL8/AL10 Non-standard Gas Meter Bank Layout – Gas Meter Boxes .....	55
Figure 53: AL8/AL10/AL12 Gas Meter Groupings .....	56
Figure 54: Gas Meter Bracket (Example) .....	57
Figure 55: Acceptable Recess or Enclosure .....	58
Figure 56: Recess or Enclosure with Fully Louvered Doors (Examples) .....	59
Figure 57: Meter Room – Example of Signage.....	60

## 1. INTRODUCTION

ATCO owns and maintains the underground network of gas pipelines in Western Australia, bringing gas to over 750,000 homes and businesses. ATCO distributes natural gas in the Perth metropolitan area, Geraldton, Bunbury, Busselton, Harvey and Kalgoorlie. ATCO also distributes LPG in Albany via its underground network. This Handbook provides guidance for installing your gas meter box and service for safe, reliable and efficient connection to all of ATCO's distribution networks.

New developments typically have buildings that occupy a larger portion of the block and there are an increasing number of developments located in elevated positions. The changing designs of these developments can compromise standard gas meter box locations. ATCO wishes to avoid delays by providing information to the industry at design stage, eliminating costly alterations and variations during construction.

The requirements in this handbook are to be followed by all Responsible Persons (Developers, Builders, Gasfitters, Owners, Customers, and any related Contractors) to help avoid delays or additional work and costs being incurred.

This Handbook is a "live" document and is subject to change.

The Feedback Form, (refer to [Appendix D](#)), can be used to provide ATCO with improvement suggestions relating to this document.

## 1.1 Glossary

Term	Definition
ATCO	ATCO Gas Australia (ATCO's gas division)
Building Frontage	The elevation of the building that faces the relevant gas main or service which connects the property
GNIS	Gas Network Information System
Nib Wall	A short section of wall adjoined to the main building that protrudes at 90°
PLS	Pre-laid Service
PLSS	Pre-laid Service Under Stairs
Responsible Person	Developer, Builder, Gasfitter, Owner or Customer

## 1.2 Contact Information

Contact Information	
ATCO Faults and Emergencies:	Phone: <b>13 13 52</b>
ATCO Scheduling Centre:	Phone: <b>13 13 56</b> , or <a href="mailto:scheduling@atco.com">scheduling@atco.com</a>
ATCO Business Development:	Phone: <b>13 13 56</b> , or <a href="mailto:bd@atco.com">bd@atco.com</a>
ATCO Drawing Office:	Phone: <b>13 13 56</b> , or <a href="mailto:drawing.office@atco.com">drawing.office@atco.com</a>
ATCO Engineering Services:	Phone: <b>13 13 56</b> , or <a href="mailto:eservices@atco.com">eservices@atco.com</a>
ATCO Enquiries:	Phone: <b>13 13 56</b> <a href="mailto:enquiries@atco.com">enquiries@atco.com</a>
ATCO Website:	<a href="http://www.atcogas.com.au">www.atcogas.com.au</a>
Dial Before You Dig (DBYD):	Phone: <b>1100</b> , or <a href="http://www.1100.com.au">www.1100.com.au</a>

## 2. INSTALLATION RESPONSIBILITIES

This section provides information on the restrictions and conditions placed on where gas meter boxes may be located. Graphics are provided throughout this Handbook to illustrate both correct and incorrect installations.

### 2.1 Requirements of the “Responsible Person”

ATCO recommends that the Responsible Person complete the Gas Connection Checklist, (refer to [Appendix A](#)).

It is the responsibility of the person requesting a gas service (the “Responsible Person”) to ensure they are fully aware of:

- The connection process as detailed in the [Connection Process Handbook](#)
- Their responsibilities and obligations to achieve a prompt, efficient service connection that meets the requirements provided within this document

Specific responsibilities include:

- Locate the gas meter box in a conforming position
- Provide information and plans for any known location of soak wells, reticulation pipes or other services or below-ground obstructions
- Arrange any reinstatement inside the property line, including associated costs
- Provide authorisation approval for any excavation inside the property line required to complete the gas connection, i.e., Notice of Acceptance or [Gas Service Installation On Hold Form](#), refer to [Appendix B](#)
- Ensure line of service is free from hazards or obstructions (e.g., building material, protruding building footings or vegetation)
- Ensure gas meter box is installed entirely within the property boundary for the property requiring the gas connection, unless other written arrangements have been accepted by ATCO. (It is the Responsible Person’s responsibility to make contact with the appropriate Council/Shire to gain written approval. This written evidence **Must** then be sent to and accepted by ATCO before the installation is completed)

Following the installation of the gas service, a gas meter and regulator assembly will be fitted with a security disc located in the gas meter outlet. The customer’s Gasfitter is responsible for commissioning (introducing gas into) their supply piping downstream of the gas meter and commissioning gas appliances.

### 2.2 Avoiding Delays in Gas Service Installation

The installation of a gas service may be delayed for a number of reasons and ATCO may place an installation on hold until the reason for the delay is rectified by the Responsible Person.

ATCO will leave a [Gas Service Installation on Hold Form](#), (refer to [Appendix B](#)) in the gas meter box (for new dwellings) or in the letterbox (for existing premises).



Some examples of situations where delays may occur include:

- The gas meter box is installed in a non-compliant position such as:
  - Too close to a window that can be opened
  - Meter box installed too high
  - Footing requires cutting to accommodate the gas service riser
- Paving or driveway is installed beneath gas meter boxes and permission is required in order to remove or lift paving
- Rubble or debris is on the line of service route preventing access for installation

### 2.3 Internal Property Reinstatement

Internal property reinstatement refers to any reinstatement and restoration of surfaces inside the property boundary, including but not limited to, paving, driveway and lawns.

If paving or other finished surfaces are required to be lifted or removed in order to install the gas service, the Customer, Builder or Gasfitter is responsible for the reinstatement.

For an established premise, it is the Gasfitter's responsibility to obtain the Responsible Person's signature at the foot of page 1 of the [Gas Service Installation on Hold Form](#), refer to [Appendix B](#), confirming that they agree to the conditions of the installation. The Gasfitter **Must** leave the form in the gas meter box. The responsible person should also contact the ATCO contact centre to remove the job off Hold (13 13 56).

For new connections, the Builder or Gasfitter **Must** sign the permission letter, and this **Must** be left in the gas meter box. The Builder or Gasfitter should also contact the ATCO contact centre to remove the job off Hold (13 13 56).

### 3. CONNECTING TO THE GAS NETWORK

This section provides information on the connection process, gas availability, gas meter box accessibility and network connection, including connection to pre-laid services.

#### 3.1 Connection Process

##### 3.1.1 Single Residential House

**Figure 1** illustrates the process to have natural gas connected to a property:

**Figure 1: Overview – Request for Gas**

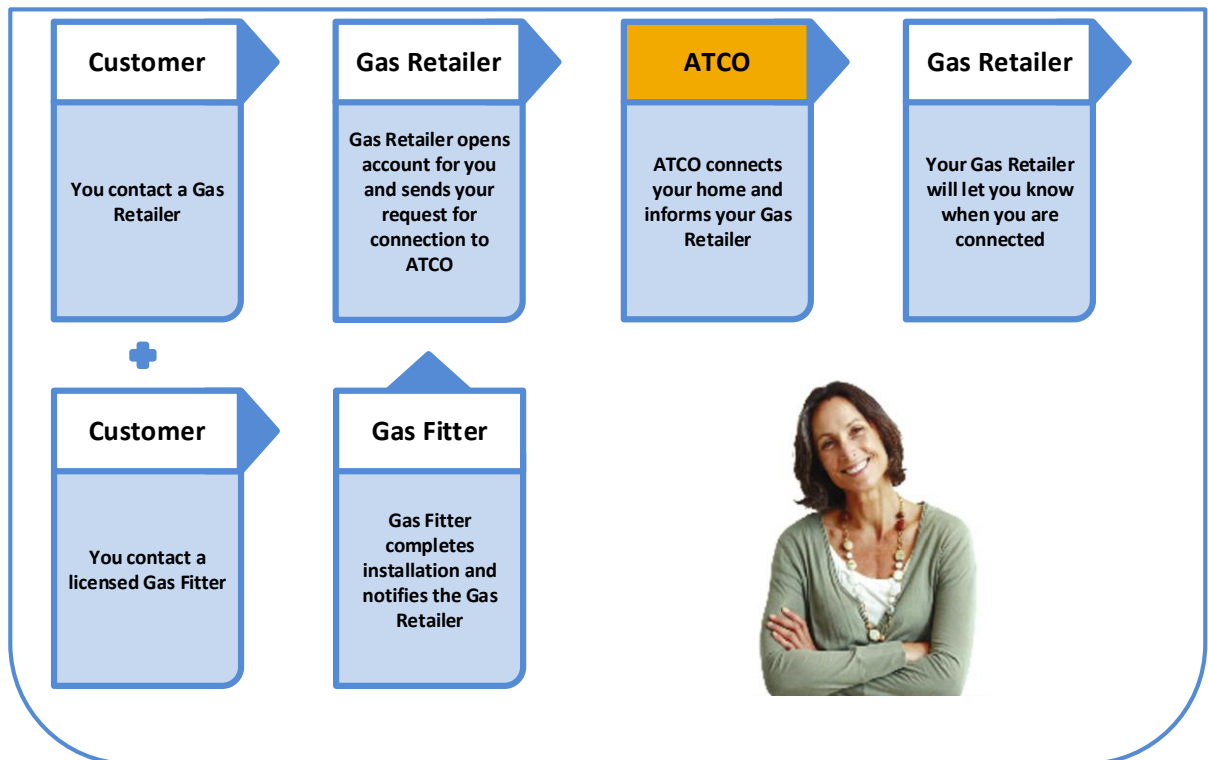

##### 3.1.2 Multi-unit Connection Process

For details regarding the Multi-unit connection process, refer to [AGA-A&C-GL05 Residential Unit Development Handbook](#).

##### 3.1.3 Commercial Gas Connections

For Commercial Gas Connections, refer to section [3.5.6](#).

### 3.2 Determining Gas Availability

To determine if gas is available to the property, please contact a gas retailer.

If gas is not outside the property but in an adjoining street, or if there is no appropriate gas main in the vicinity, then a mains extension may be required to bring gas to the property. If requested, a gas retailer will organise a quotation from ATCO to extend the gas main to the property.

Where a gas connection cannot readily be made because there is no direct street frontage to a gas main (e.g., a property on a rear laneway without gas mains), refer to section **4.1.10**.

### 3.3 Gas Meter Size and Diversification

Typical gas meter sizes are addressed in **Table 1** and **Table 2**, while diversity factors are addressed in **Table 3**.

**Table 1: Gas Meter Selection (for Natural Gas Domestic Installations)**

Meter Type	Diversified Load Meter Capacity		Always Consider Gas Load Diversity Typical Number of Appliances
	1.25 kPa	2.75 kPa	
AL8	8 m <sup>3</sup> /hr 300 MJ/hr	8 m <sup>3</sup> /hr 300 MJ/hr	Up to 4, including 2 hot water systems
AL10	10 m <sup>3</sup> /hr 375 MJ/hr	10 m <sup>3</sup> /hr 375 MJ/hr	5-6, including 3 hot water systems
AL12	12 m <sup>3</sup> /hr 450 MJ/hr	25 m <sup>3</sup> /hr 940 MJ/hr	Typically 7+
AL18	18 m <sup>3</sup> /hr 660 MJ/hr	38 m <sup>3</sup> /hr 1365 MJ/hr	Typically 15+
For further details contact ATCO, or your Gasfitter			

**Table 2: Gas Meter Selection (for LPG Domestic Installations)**

Meter Type	Diversified Load Meter Capacity (LPG)	Always Consider Gas Load Diversity	Applications
	2.75 kPa	Typical Number of Appliances	
AL8	4.8 m <sup>3</sup> /hr = 450 MJ/hr	Up to 6 including 3 hot water systems	All LPG domestic sites and small commercial installations
AL10	6.5 m <sup>3</sup> /hr = 610 MJ/hr	7+	Small commercial installations
AL12	15.2 m <sup>3</sup> /hr = 1430 MJ/hr	15+	Commercial only. Consult with ATCO's Gas Utilisation Inspectors or Engineering before requesting

**Table 3: Gas Meter Diversity Factors (for Domestic Installations Only)**

Domestic Gas Appliance Description	Diversity Factor*
Gas pool/spa heater	0.8
Gas hot water system – continuous type (highest MJ rated unit)	0.8
Gas hot water system – continuous type (2 <sup>nd</sup> unit if fitted)	0.2
Gas hot water system (storage type)	0.6
Gas room heater (portable, fireplace, ducted or other)	0.6
Gas clothes dryer	0.6
Gas hotplate/oven/BBQ (separate devices)	0.6
Gas cooker (combined hotplate with oven)	0.4
<b>Note:</b> *Based on British Standard BS-6400-1 as updated in accordance with the ATCO Gas Australia Technical Notice available at <a href="http://www.atcogas.com.au">www.atcogas.com.au</a>	
<b>To calculate</b> the size of the gas meter required:(Domestic Only)	
<ul style="list-style-type: none"> <li>• Multiply the maximum Megajoule/hr rating for each appliance by its applicable diversity factor</li> <li>• Add all individual appliance diversified gas loads together</li> <li>• Refer to gas meter selection table</li> </ul>	
<b>Additional Notes:</b>	
<ul style="list-style-type: none"> <li>• For more than two (2) continuous hot water systems, alternate 0.8 and 0.2 diversity factors for all remaining units</li> <li>• The Gasfitter <b>Must</b> apply diversity to all gas meter selections. <b>Do Not</b> specify a gas meter larger than AL8 unless the gas load exceeds 300MJ/hr after diversity has been applied</li> </ul>	

Refer to section 5.1 for meter box dimensions.

### 3.4 Accessibility

A gas meter is not to be located behind a locked gate. A minimum **1000 mm** clearance is required to be maintained in front of the gas meter box **at all times**. Accessibility to gas meter boxes is required to allow for the provision of:

- Gas service pipe installation
- Emergency shut-off (e.g., property fire)
- Maintenance
- Gas meter reading
- Inspection

All efforts should be made to locate the gas meter box in an accessible location. If this is not possible due to limitations of the site, an ATCO representative may, on a case-by-case basis, give permission for a locked meter box. (Refer to 3.4.1)

#### 3.4.1 Mandatory Lock Requirements

The following mandatory lock requirements ensure prompt access for ATCO (to any compartment, enclosure or gas meter box) for maintenance and emergency purposes. Locks not

meeting these requirements or otherwise restricting ATCO access will be removed. ATCO requires locks to be fitted prior to the gas connection taking place.

The lock (barrel or padlock) **Must** have the ability to be accessed by the following two keys:

1. Y07 Profile Master Key.
2. Western Australia Services (WAS Lock) Master Key.

**Note:** Refer to the relevant power authority for locking details of electrical meter boxes.

### 3.4.2 Viewing Apertures for Locked Enclosures

Approved viewing apertures (refer to **Figure 2**) are mandatory on gas meter boxes that are to be fitted with locks. The viewing aperture **Must** be placed so that the gas meter index can be read without having to unlock the gas meter box door.

**Figure 2: Gas Meter Box Viewing Aperture – Example**



## 3.5 Service Connection

The gas network connection point is normally pre-determined by the location of a Pre-laid Service (PLS) or Pre-laid Service under Stairs (PLSS), prior to selecting an approved gas meter box location.

### 3.5.1 Connection without Pre-laid Service (PLS)

Where there is no PLS or PLSS, the line of service between the gas meter box and the gas connection point in the roadway is to be considered, ensuring the route is unhindered and free from hazards and obstructions. For additional details refer to section 4.4.

### 3.5.2 Connection to Pre-laid Services (PLS and PLSS)

In the majority of new subdivisions, a **PLS** or **PLSS** is installed in a common trench to the boundary line of a property when the subdivision is developed.

The line of service between the gas meter box and the **PLS** is to be considered, ensuring the route is unhindered and free from hazards and obstructions. For additional details refer to section 4.4.

**Figure 3** shows an example plan from ATCO's Gas Network Information System (**GNIS**) (available through Dial Before You Dig (**DBYD**)). It is an example of a new subdivision where gas mains have been installed in road reserves, including rear laneways, to both typical flat lots and elevated lots. The **PLS** notation indicates the side of the lot where the service has been installed. Historically, one **PLS** connection normally supplied two adjoining lots, however, ATCO has moved to providing a tee configuration for a **PLS** connection in which each side of the tee goes to one of the adjoining lots. The gas meter position **Must** allow direct (straight) access to the **PLS** ensuring no part of the gas service is covered by a future building structure, (e.g., a carport or garage).

**Figure 3: Plan Showing Gas Mains and Pre-laid Service Locations**

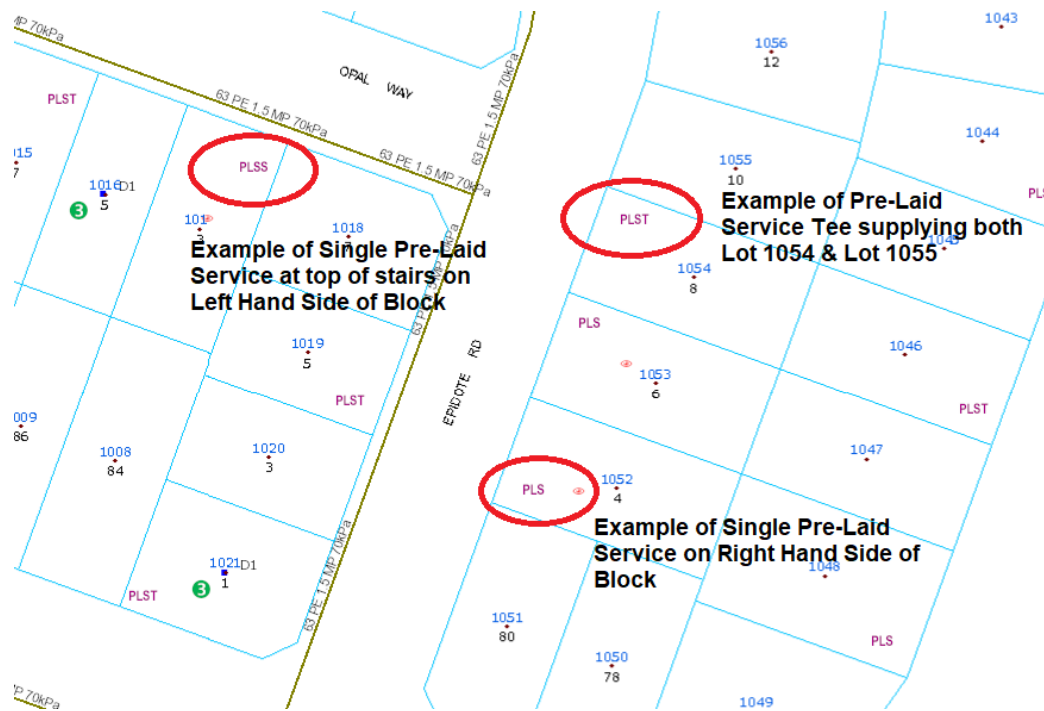

**Figure 4** shows a typical connection to a **PLS**. When the service is to be connected to a **PLS**, (generally in new subdivisions) the service is laid in a straight line from the **PLS** or **PLSS** to the gas meter box position at a depth of **600 mm**.

**Figure 4: Typical Connection to a Pre-laid Service**

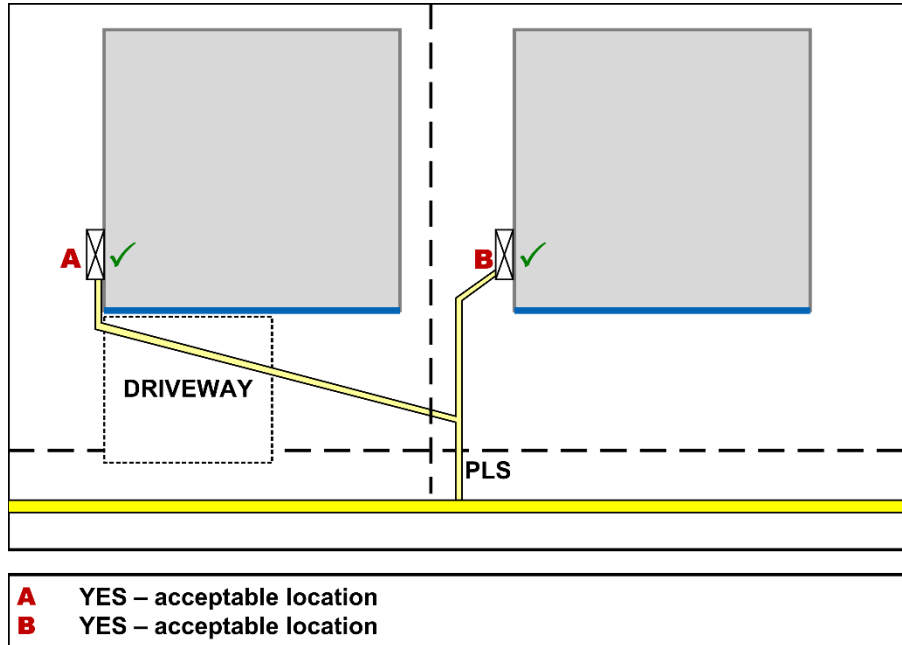

Where a gas service is to run from the **PLS** under a driveway, the gas service **Must** be installed prior to construction of the driveway. If this is not achievable, permission to lift the driveway will be sought from the customer; it will be the responsibility of the customer, Builder or Gasfitter to reinstate inside of the boundary.

### 3.5.2.1 Pre-laid Services with Retaining Walls

With the introduction of retaining walls into subdivisions (refer to **Figure 5** for a typical view), gas services have been catered for in a variety of methods.

- The **PLSS** method has the gas service installed beneath the retaining wall stairs, terminating at top of stairs. Refer to **Figure 5** and section **4.1.3** for details
- The rear laneway method has the gas service installed from the rear laneway to the typical **PLS** alignment. Refer to section **4.1.2** for details

The Responsible Person should determine the **PLS** or **PLSS** location on the lot being developed when determining the gas meter box position for a new dwelling. If the **PLS** is located in a rear laneway, the gas meter box **Must** also be positioned in that laneway (in a compliant location).

ATCO will only connect to the **PLS** or **PLSS** (if installed) located inside the lot boundary as per the **PLS** or **PLSS** design which was installed to that lot at development stage.

The Responsible Person **Must** ascertain the **PLS** or **PLSS** location and ensure accessibility for gas service pipe installation to the gas meter box position.

If a gas meter box is located in a position which may become inaccessible, then ATCO **Will Not** approve the connection.

**Figure 5: Stairways at Front of Properties**



**Figure 6: Pre-laid Gas Services Installed Under Stairways (PLSS)**

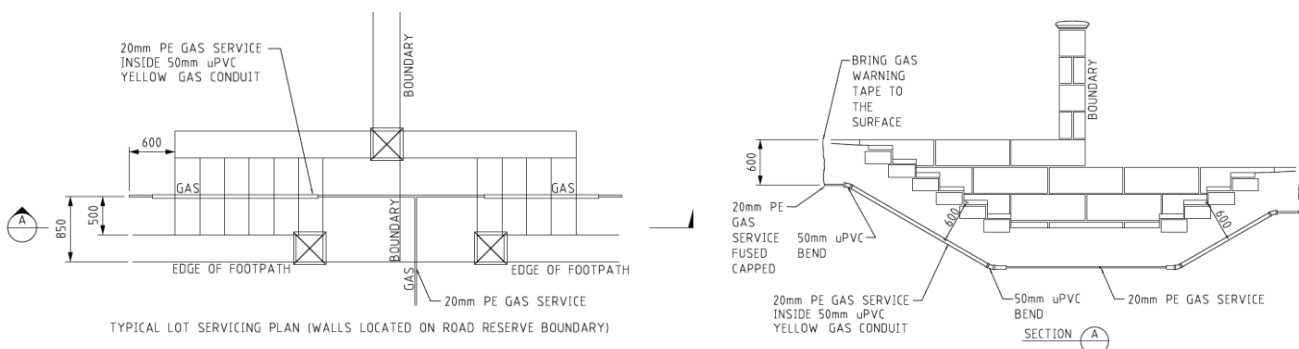

### 3.5.3 Service Sleeve/Conduit (Retaining walls, Elevated lots)

If a sleeve is to be installed (through which the gas service pipe will be inserted later) **this Must be discussed with, and agreed by, the ATCO Supervisor. ATCO will not utilise a sleeve that it has not approved.**

Basic requirements for a sleeve are:

- Material **Must** be approved gas pipe (Yellow Gas Pipe). Drain/stormwater pipe **will not** be approved, and if already installed, **will not** be utilised
- The minimum depth of cover is **600 mm** for a single service (**750 mm** for a multi-unit development – i.e., two or more) and a minimum of **150 mm** clearance from all other assets. (Unless otherwise approved by an ATCO representative)
- Ends **Must** be temporarily capped, once installed, to prevent water/sand ingress (Prior to gas service being installed)
- **Must** be for gas only (No other services are allowed to utilise the conduit)



- The location of the two ends of the sleeve **Must** be clearly marked above ground

If any of the above requirements are not met, ATCO will be unable to use the sleeve for the installation due to compliance restrictions. This may cause unnecessary delays.

### 3.5.4 Designated Boundary Connection Areas

Some areas, including in the Perth hills, are designated as boundary connection areas – refer **Figure 7** for an example representation. In these areas, the standard gas meter box **Must** be located on the main fronting boundary line of the property. If another location is chosen for the gas meter box, the Responsible Person **Must** provide an open trench from the main fronting boundary line of the property to the gas meter box position.

Additional charges apply for services over **20 m** in length inside the boundary. This cost will be applied to the gas bill a customer receives from its gas retailer.

The gas retailer will advise the customer if the site is a Designated Boundary Connection Area. If further clarification is required, a customer can contact its gas retailer to confirm if the area is highlighted as ‘Hard Digging’ as shown below.

**Note:** As shown in **Figure 7** below, the entire area is highlighted yellow. This is a designated ‘box on boundary’ area.

**Figure 7: Example Screen Shot – Designated Boundary Connection Area**

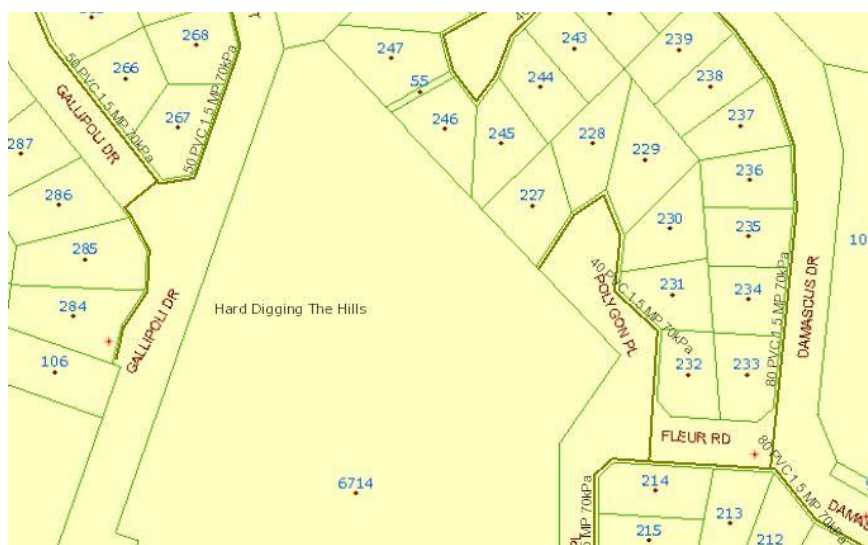

### 3.5.5 Gas Services to Large Rural or Semi-rural Lots

The gas meter box should be mounted on the main fronting boundary line of the property. Alternatively, it may be mounted on the primary building in a suitable, compliant position. Additional charges will apply to customers for services over **20 m** in length.

All of the following conditions **Must** be met by the Responsible Person providing the open trench:

- A suitable straight and direct trench is to be provided from the boundary to the gas meter location
- The route **Must**, as far as practicable, be at right angles to the gas main or as directed by ATCO. If the Responsible Person requires to run around an obstruction (such as a soak well) please provide a site plan showing the trench alignment to ATCO

- The bed of the trench **Must** be soil that is free from rock or other sharp formation that may cause damage to the Polyethylene (PE) gas service pipe
- The minimum depth of cover is **750 mm** for open trench bookings

A front boundary connection is the preferred option when the Building Frontage is greater than **20 m** from the boundary line.

### 3.5.6 Connection to Commercial Properties (AL8, AL10, AL12, AL18 Gas Meters)

A site visit by an ATCO Representative will be required for all new gas connections to a commercial property before installation. [Contact ATCO Scheduling for all enquiries 13 13 56.](#)

**Note:** AL8 and AL10 gas meters are the same dimensions and use the same meter box.

**Note:** AL12 and AL18 gas meters are the same dimensions and use the same meter box and manifold.

Installation of an AL18 gas meter, or greater, requires a Commercial Gas Request (CGR) to be submitted to ATCO by the gas retailer.

The siting of gas meters for commercial properties is subject to the conditions detailed in this document. Gas meter boxes for commercial properties should be mounted on the boundary in a protected location. Where a gas meter box is not located on the boundary, an open trench **Must** be provided by the Gasfitter, Builder or Customer. Once the site visit has been completed by the ATCO Representative and the Gasfitter, Builder or Customer, Contact 13 13 56 to book an open trench a minimum of ten (**10**) working days in advance, additional days are preferred to allow for scheduling.

## 4. GAS METER BOX LOCATIONS

This section sets out requirements for the location of gas meter boxes. Refer also to the relevant power authority in instances where combination gas/electric meter boxes are to be installed.

- The line of service between the gas meter box and the gas connection point is to be considered, ensuring the route is free from hazards/obstructions, and is straight
- Gas meter boxes **Must** be installed in a location not greater than **1000 mm** behind the Building Frontage of a dwelling or located at the rear of a property due to access restrictions (unless approved by an ATCO representative). For further information contact [enquiries@atco.com](mailto:enquiries@atco.com)

**Note:** Building Frontage is defined as the elevation of the building that faces the relevant gas main or service which connects the property.

















### 4.1 Gas Meter Location – Examples

The following figures show typical house designs indicating the Building Frontage and acceptable/unacceptable gas meter box locations for each example case:

- Standard house
- Rear laneway
- Pre-laid Service at top of stairs (double stairway)
- Pre-laid Service at top of stairs (straight on single stairway)
- Carport
- Elevated lot with retaining wall
- Tiered Blocks
- House with swimming pool
- Property without street frontage or gas availability

Refer to **Figure 8** below for symbols and colours used to help interpret these figures.

**Figure 8: Legend for Diagrams**

Legend			
	Bollard		Meter Box
	Boundary Line		Meter Box Acceptable Location
	Building		Meter Box Unacceptable Location
	Building Frontage		Nib Wall
	Electric Power Dome		Patio Enclosure
	Exclusion Zone		Retaining Wall
	Gas Main		Retaining Wall Backing Blocks
	Pre-laid Service (PLS or PLSS)		Stairway

4.1.1 Standard House

A typical standard house is shown in **Figure 9**.

**Figure 9: Standard House**

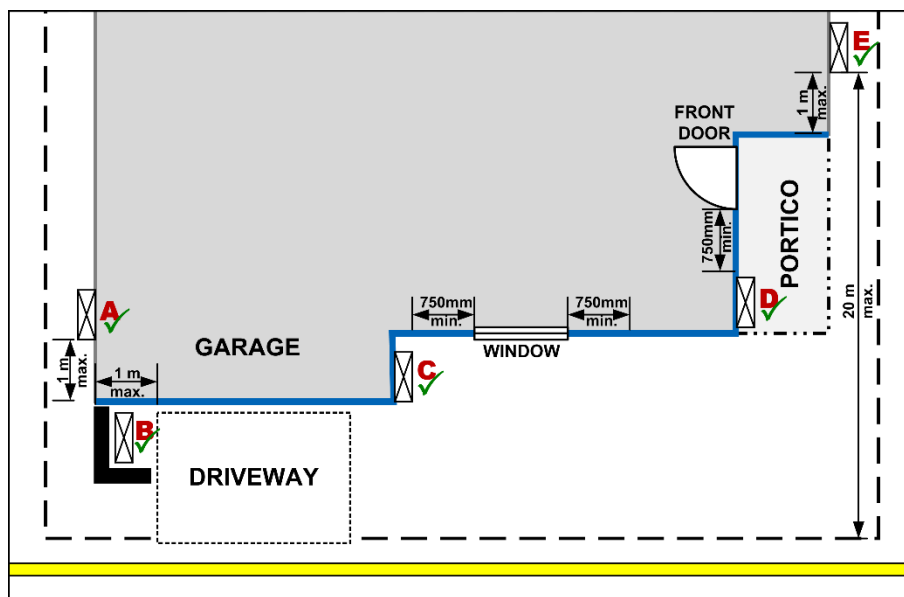

<b>A</b>	YES
<b>B</b>	YES – recommended position (nib wall)
<b>C</b>	YES
<b>D</b>	YES
<b>E</b>	YES

**Note: Location D** is only acceptable if the portico has two (or more) open sides which allow sufficient natural ventilation, the gas meter box **Must** be installed within **1 metre** of the front opening.

**Note: Location E** - Minimum separation from the gas meter box to the boundary **Must** be **1 metre**.

#### 4.1.2 Rear Laneway (Must Determine Gas Availability)

Prior to any construction works commencing, the customer or responsible Gasfitter **Must** contact the retailer to confirm that gas is available in the rear laneway as a **PLS** may have been already provided in an alternative location (refer **Figure 10**). Refer to **Figure 11** for guidance regarding location of the gas meter box.

**Figure 10: Laneway Example (Box on Boundary)**

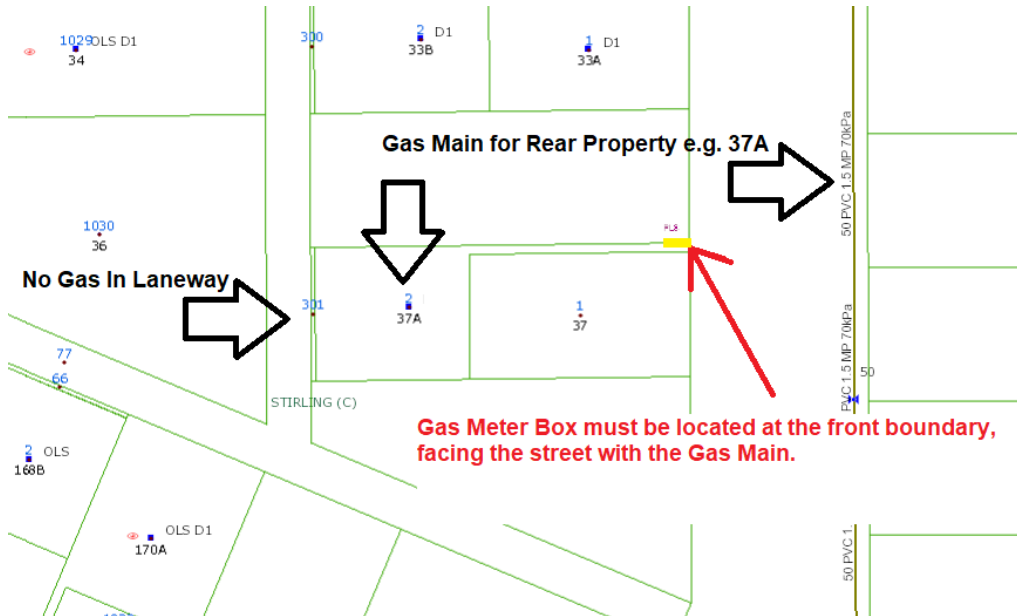
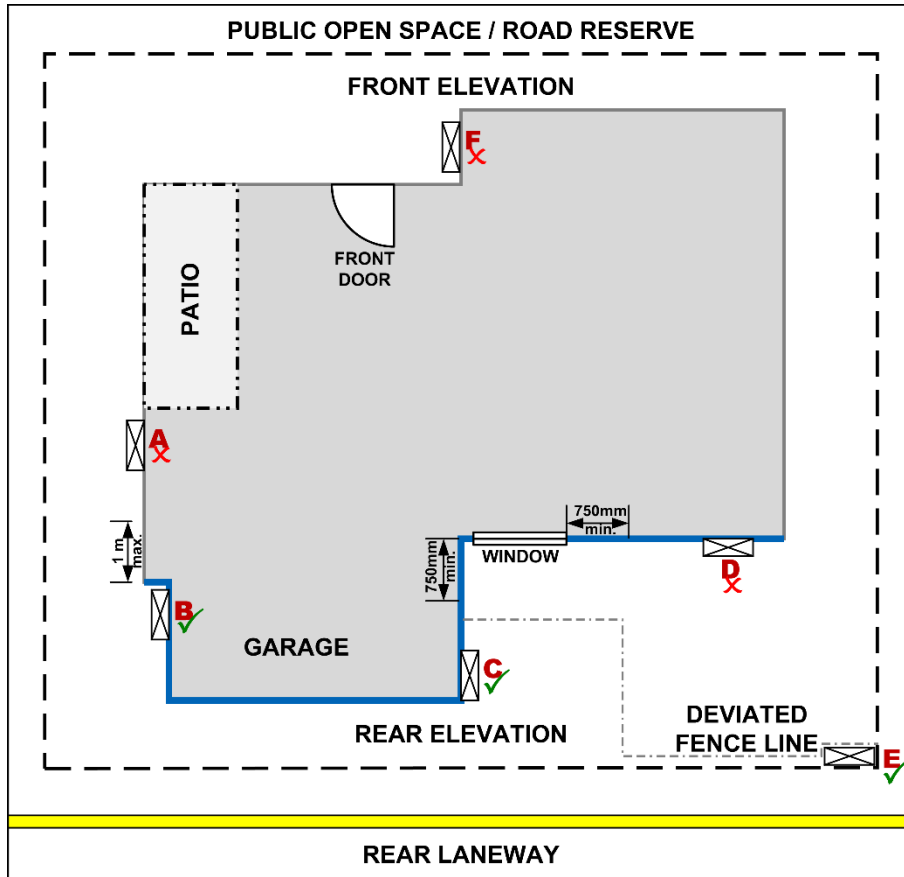

Figure 11: Rear Laneway (Gas Available)



- A** NO – too far from building frontage
- B** YES – if access to meter box is maintained, i.e., not permitted behind gate or fence
- C** YES, refer to B
- D** NO – meter box not to be installed behind fence with no gate access
- E** YES – meter box on boundary access (fence line deviated to accommodate gas meter box and provide access)
- F** NO – too far from building frontage (incorrect elevation as gas is catered to block at rear of property)



Position 'B' in diagram above

(Providing clearances and separation are achieved – refer sections 3.4 and 5.5)



Position 'C' in diagram above

4.1.3 Pre-laid at Top of Stairs/Retaining Wall

A typical pre-laid service at the top of stairs with retaining wall is shown in **Figure 12** for a double stairway configuration and **Figure 13** for a single straight on stairway.

One (1) metre is the minimum house wall setback distance required to physically install a gas service to avoid retaining wall backing blocks and ensure safe separation from the house slab is maintained. A reduced setback may be applied where backing blocks do not exist, or where site-specific circumstances have required a “non-standard” design.

The distance between the meter box and any boundary wall **Must** be a minimum of **1000 mm** to be able to pass the gas service through this area. If the separation distance of the meter box is less than **1000 mm** from the boundary or the lowest part of a tiered retaining wall, an alternative compliant location **Must** be obtained.

**Figure 12: Pre-laid at Top of Stairs (Double Stairway)**

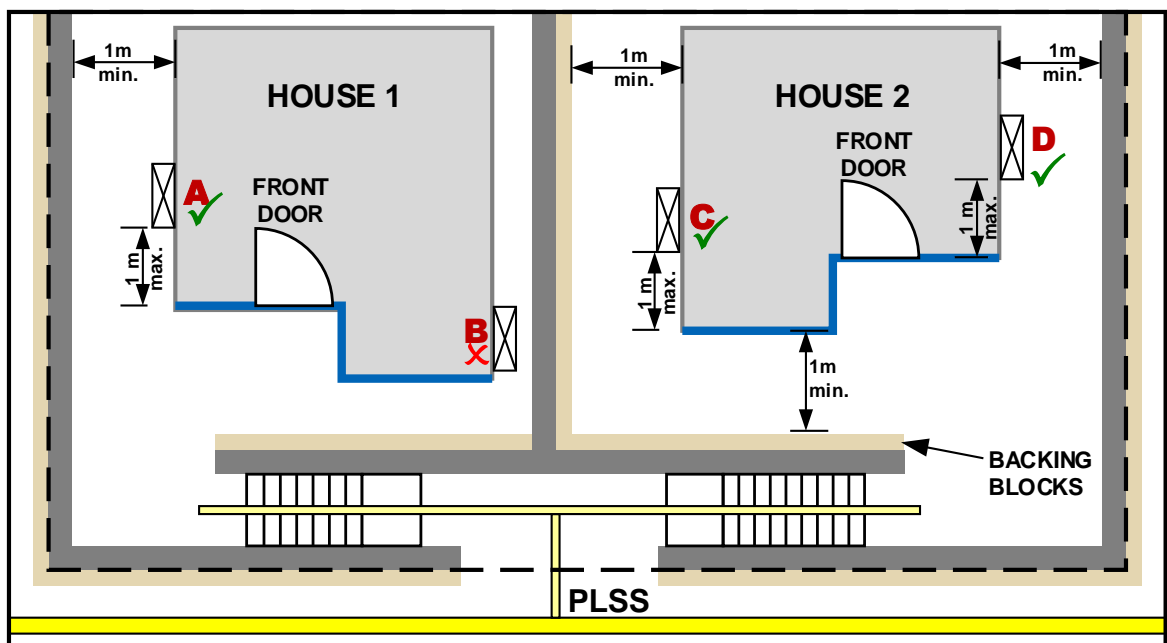

- A** YES
- B** NO Insufficient space between house and retaining wall.
- C** YES
- D** YES

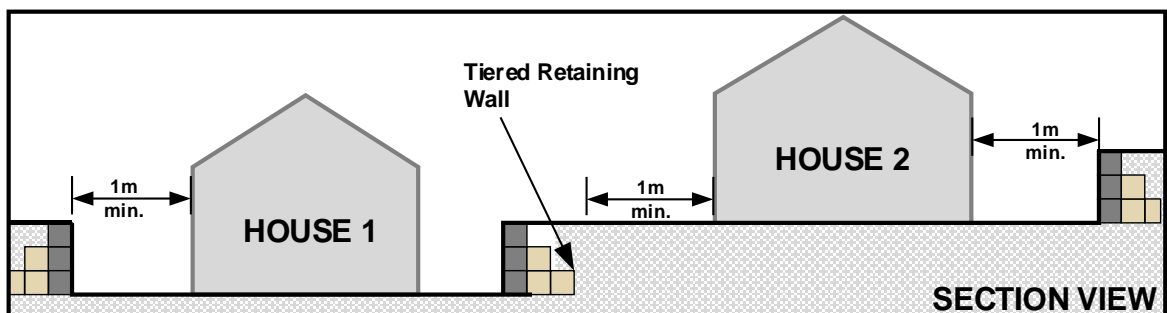
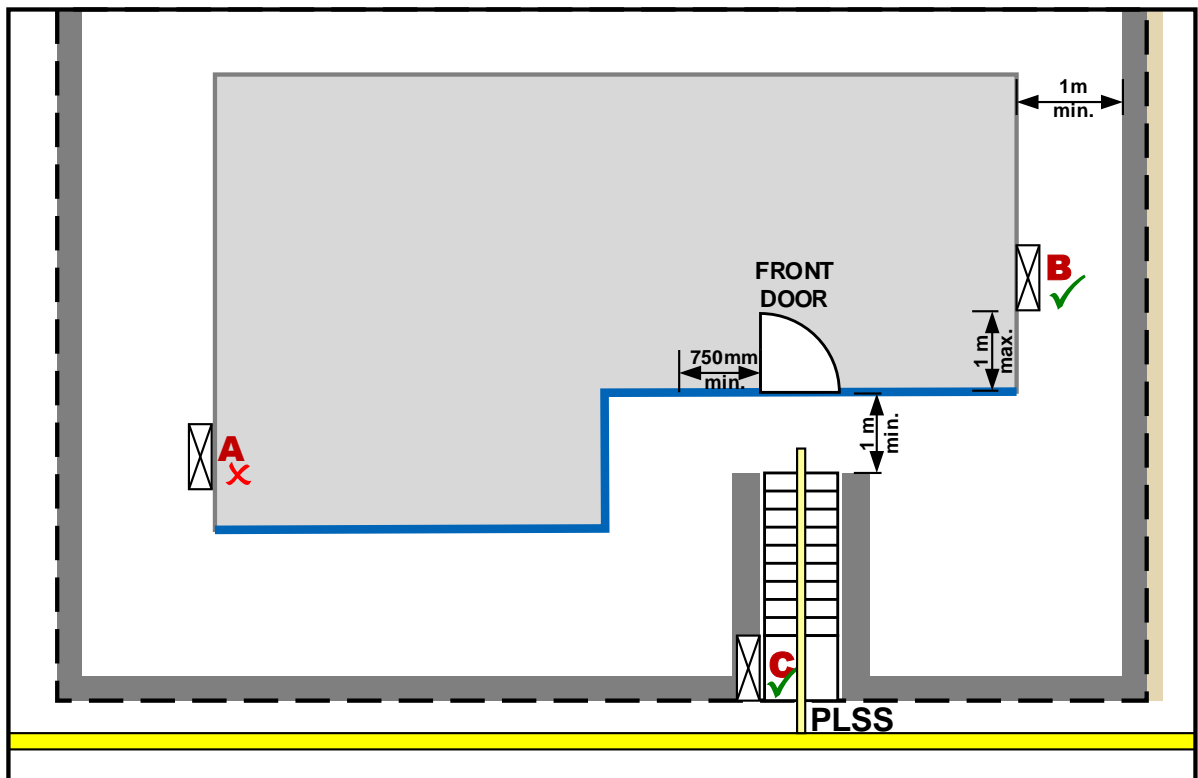

Figure 13: Pre-laid at Top of Stairs (Straight on Single Stairway)



- A NO** No path for line of service.  
**B YES**  
**C YES** Recommended position (recessed in wall) in landing at bottom of stairs. Refer to Meter Box (Fully Recessed) section of this document.

#### 4.1.4 Service Separation Requirements

A minimum separation distance of **150 mm** is required between the gas service and any other utility. The location of the gas service is directly related to where the meter box is placed, thus the placement of the meter box **Must** consider the gas service separation requirements. As most utilities will use the same corridor, a minimum of **1000 mm** clearance is required between a meter box location and any part of a retaining wall that will prevent a service installation to a depth of **600 mm** (See “Section View” of **Figure 12**). This **1000 mm** corridor to a depth of **600 mm** is required to facilitate the service separation requirements.

Meter boxes placed further away from the Pre-laid Service have increased complications with service separation which may result in a non-compliant scenario.



**Figure 14: Non-compliant Service Separation (Less than 150 mm between Utilities)**



An example of a non-compliant gas meter location due to non-compliant service separation can be seen in **Figure 14**. This scenario shows a meter box too close to a retaining wall which only gives a **100 mm** corridor to a depth of **600 mm** where all utilities have been installed. This has resulted in separation distances far less than the required **150 mm** as shown in **Figure 15**.

**Figure 15: Minimum Utility Separation Distance Requirements (Gas Service Only)**

Minimum required separation from a gas service and any other Utility or obstruction is **150 mm**. All services **Must** be outside of the power dome exclusion zone.

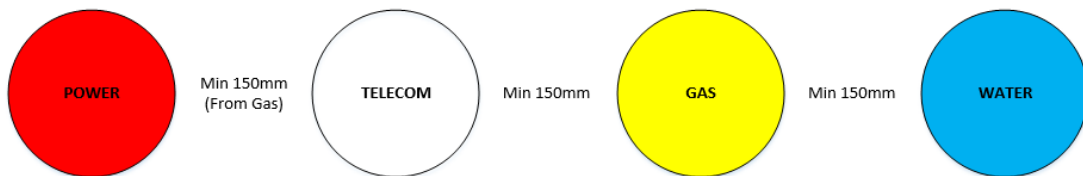

**MINIMUM REQUIRED SEPARATION FROM A GAS SERVICE AND ANY OTHER UTILITY OR OBSTRUCTION IS 150MM**  
 (This applies to the gas service, and copper service riser, the gas mains require a greater minimum distance of 300mm)

ALL UTILITIES MUST BE OUTSIDE OF THE 1 METER EXCLUSION ZONE, AND MUST ALSO COMPLY WITH THE ABOVE SEPARATION DISTANCES. THIS APPLIES BOTH ABOVE, AND BELOW GROUND.

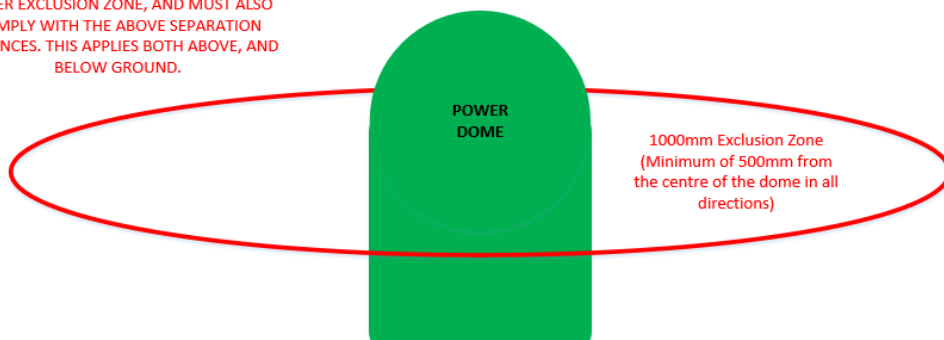

### 4.1.5 Carport

A typical consumer property with carport is shown in **Figure 16**. The gas service cannot be installed under any part of the main concrete slab.

**Figure 16: Carport**

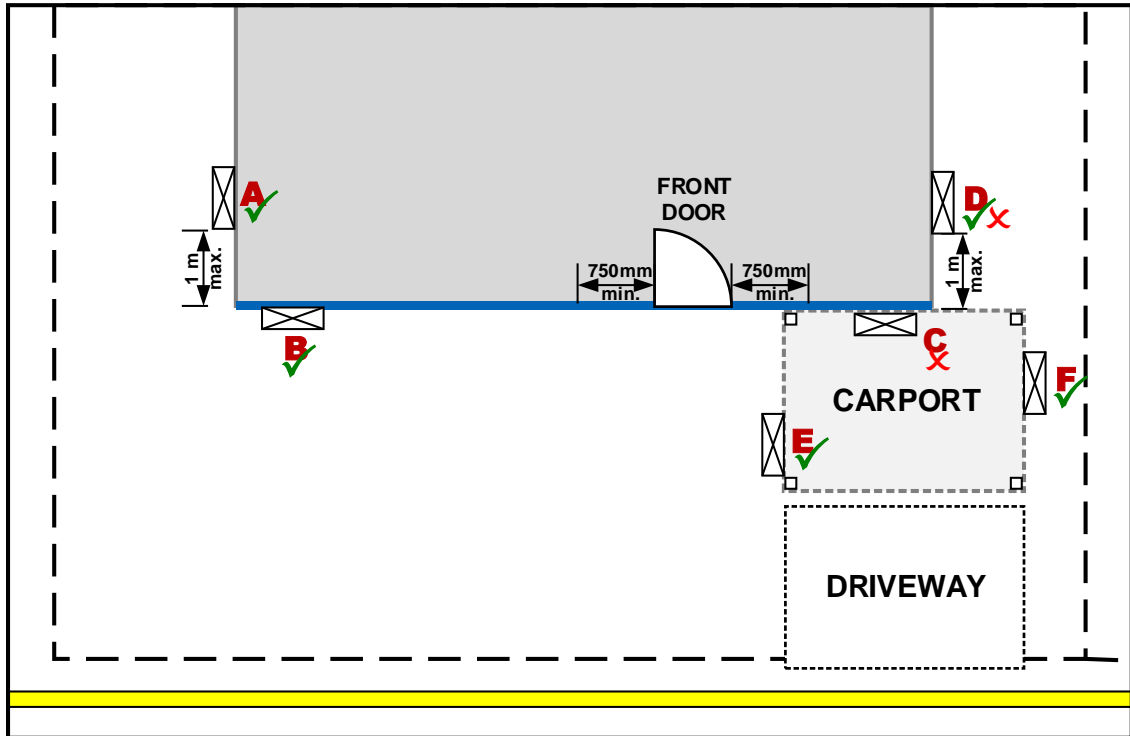

- |          |   |
|----------|---|
| <b>A</b> | <b>YES</b>  |
| <b>B</b> | <b>YES</b>  |
| <b>C</b> | <b>NO</b> Meter box cannot be installed within carport.<br>Meter not protected from vehicle interaction.  |
| <b>D</b> | <b>Y/N</b> No part of the gas service line can travel through or under any part of a building, (e.g., a carport or garage), i.e., yes only if service line does not cross through or under carport. |
| <b>E</b> | <b>YES</b> Meter box installed on legs.   |
| <b>F</b> | <b>YES</b> Meter box installed on legs.   |

An exception can be made to **Location D** if the carport installed has three (3) sides permanently open and is **Not** part of the main structure of the property (Separate structure entirely, unless approved by an ATCO Representative). This allows for sufficient ventilation and accessibility to excavate onto the gas service if required. (The carport **Must Never** be enclosed, if the gas service has been connected and the carport is enclosed, an 'Alter Meter Position' will be required). Refer to examples below.



**Acceptable** – Service Line is Ventilated



**Not Acceptable** – Concealed under Carport

4.1.6 Elevated Lot with Retaining Walls

A typical elevated lot with retaining walls is shown in **Figure 17**.

**Figure 17: Elevated Lot with Retaining Walls**

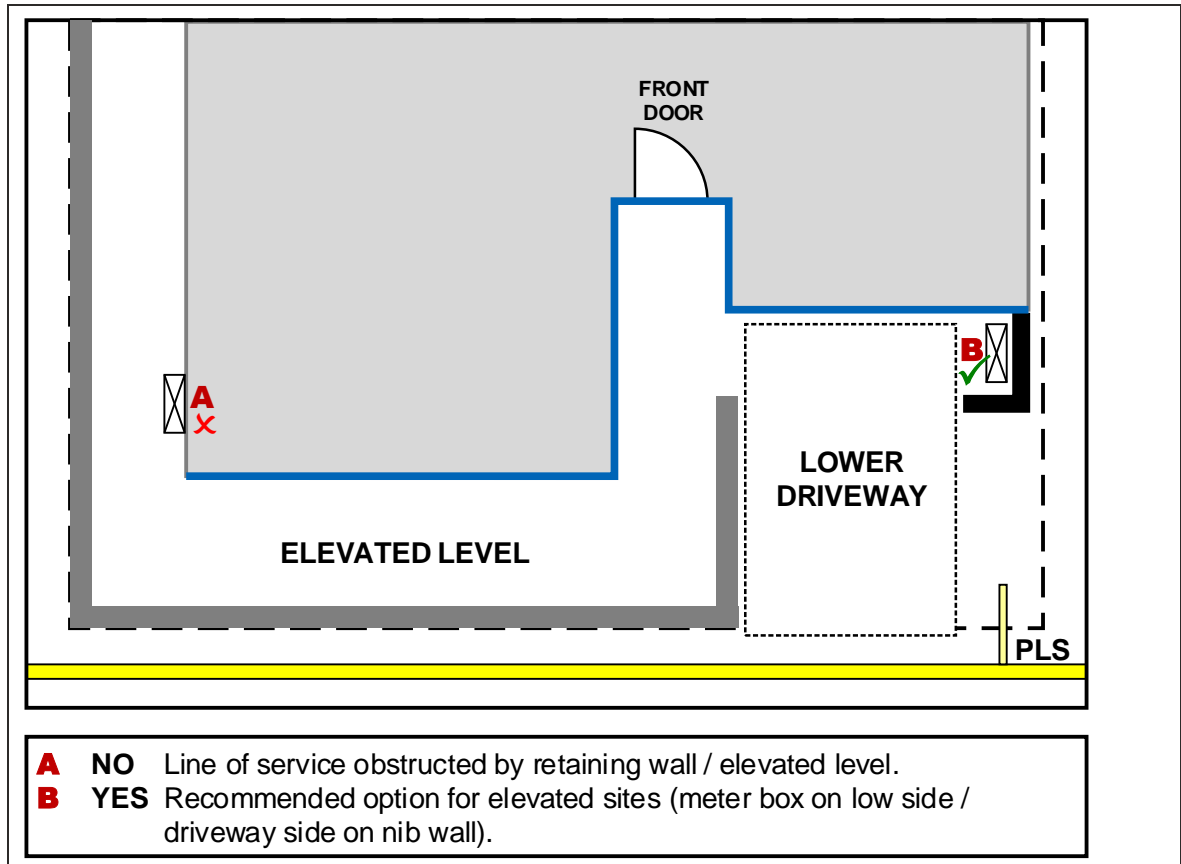

**Not Acceptable – Location A**

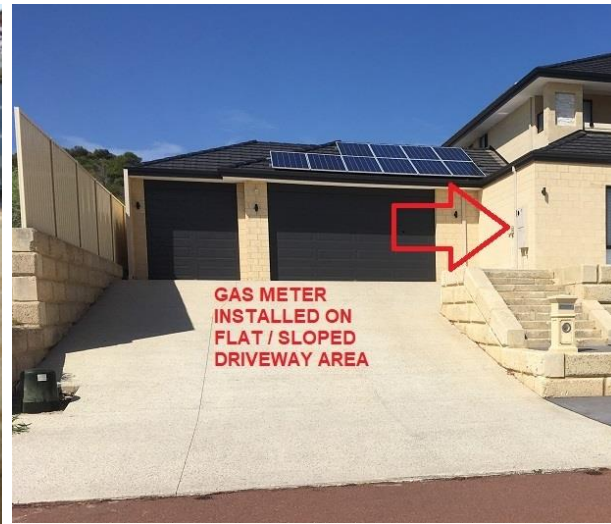

**Acceptable – Location B**

If the PLS is located at the front of the property (refer to **Figure 17**), then the gas meter box cannot be placed at Location **A** (elevated level). Instead a compliant location on the low section at the front of the property (e.g., Location **B**, freestanding, or build into a nib wall) **Must** be identified.

#### 4.1.7 Tiered or Sloping Lots/Gardens (or equivalent lower lots)

The gas meter box **Must** be installed on the front boundary. This is due to difficulties maintaining depth of cover and future accessibility of the gas service line. Gas services cannot be installed under tiered walls as this is impractical and inaccessible in an emergency (isolating the gas service), and does not allow for future replacement and repair of the gas service line. Each meter box **Must** be placed on the flat side of the lot (e.g., driveway side) that is the equivalent ground level as the verge. If this is not possible, additional information can be sought from an ATCO representative.

**Figure 18: Examples of Tiered or Sloping Lots/Gardens**



The Gas Meter Box **Must** be installed on the Boundary (Gas Service not accessible, Depth inconsistent)



The Gas Meter Box can be located at the front boundary facing the gas main. (As long as the gas meter does not encroach into the council verge; the meter box **Must** remain inside the property boundary)

#### 4.1.8 Retained Garden Beds

Gas meter boxes **Must Not** be installed above a retained garden bed in any circumstance, this is due to inconsistent depths and difficulty with accessing the gas service line for maintenance. Concrete footings are also an issue, as generally there is a footing for the main property and a second footing for the retaining wall, causing restricted space and promoting corrosion to the copper riser. Additionally, ATCO will not undermine the retained garden bed or the concrete footings that are supporting the wall.

**Figure 19: Example of a Gas Meter Box Position Placed On Hold**



This is an example of a gas meter box position placed On Hold due to being installed above a retained garden bed.

This meter box would be required to be relocated by the Builder or Gasfitter before the connection would be completed.

#### 4.1.9 House with Swimming Pool

A typical consumer property with swimming pool is shown in **Figure 20**.

**Figure 20: House with Swimming Pool**

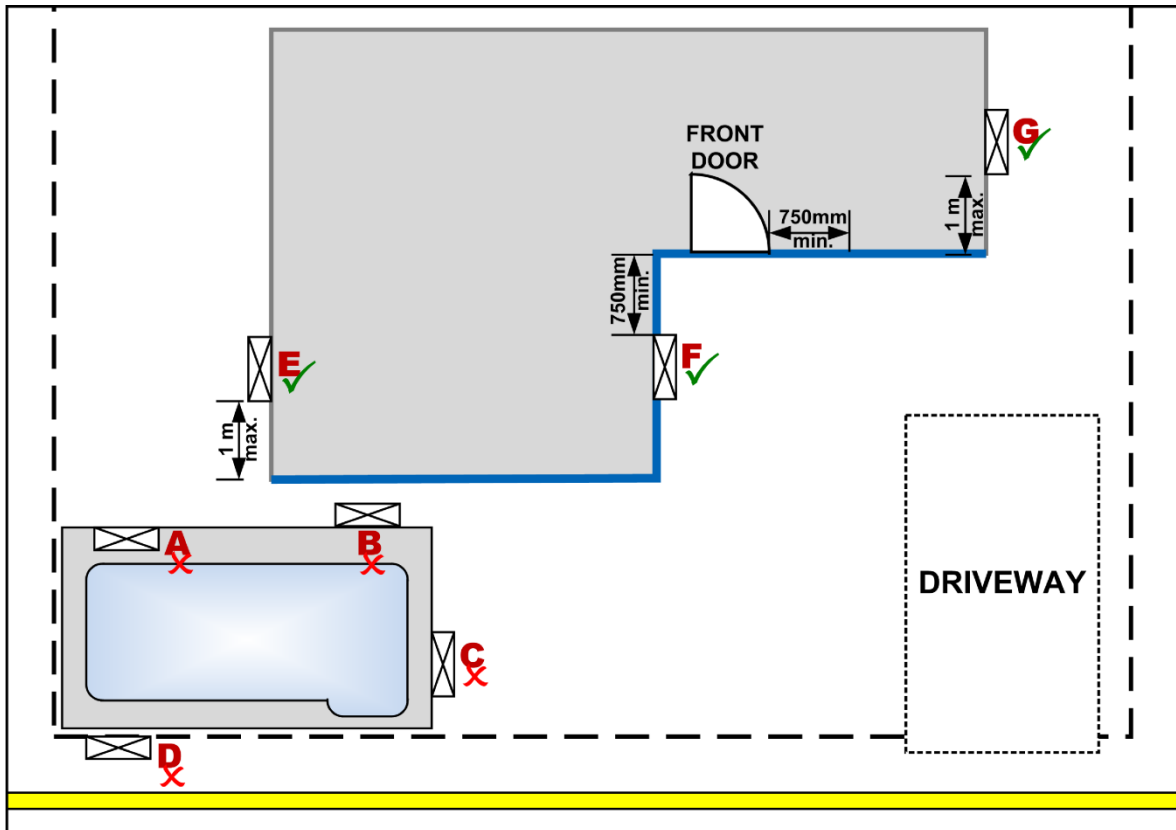

- A NO** Meter box installed inside pool enclosure.
- B NO** Meter box can be used to gain access into pool enclosure (prohibited by Council by-laws).
- C NO** Refer to B.
- D NO** Council by-law generally prohibit any part of the meter box protruding into the road reserve (even if partially recessed).
- E YES**
- F YES**
- G YES**

**Note:** A gas service line **Must Not** travel through any part of a pool enclosure, nor can the gas meter box be located within such a pool enclosure. Should any future works position the gas service/gas meter box inside the pool area, the Responsible Person **Must** complete an Alter Meter Position/Alter Service Position Request Form so that the installation complies with the requirements of this Handbook. The costs of these alterations are charged to the customer as the installation of the pool would have caused the existing gas service to now be non-compliant.

#### 4.1.10 Property without Street Frontage or Gas Availability (Access Easements)

Where a gas connection cannot readily be made because there is no street frontage or gas availability in a rear laneway, the following requirements **Must** be met: (This applies to subdivided lots with an access walkway leading from the front lot to the rear lot)

- The gas meter box **Must** be located on the boundary line or as close as reasonably practical to where gas is available up to a maximum distance of **1000 mm** from the boundary line
- The gas meter box position **Must** remain readily accessible for emergency and maintenance purposes
- Obstructions and site conditions are to be taken into account
- A 'Green Title' subdivided block **Must** have direct access to a gas main via direct street frontage. Access via an easement or across another property is **Not** acceptable unless it falls within the alignments of the Utility Providers Code of Practice for Western Australia
- For a strata property requiring a gas connection in or through common property, written approval from the Strata Company (Body Corporate) is required
- For a strata property requiring a gas connection in or through an adjoining lot (in the same strata scheme), an appropriate easement (dedicated to gas) **Must** be available and approval from the Strata Company (Body Corporate) is required. Where an easement is not appropriate, then the gas meter box **Must** be provided at the front boundary as per Location **A** shown in **Figure 21**, unless otherwise approved by an ATCO representative and the owner of the adjoining lot
- If a gas mains extension is required, it will only be installed within public dedicated roads or public dedicated rights-of-way. Installations **Will Not** be permitted within private roads or rights-of-way. As a general rule, gas mains will not be installed within existing roads or rights-of-way less than **six (6) metres** wide unless there is no alternative route or means of obtaining safe access as determined at the discretion of ATCO.

**Figure 21: Property without Street Frontage or Gas Availability**

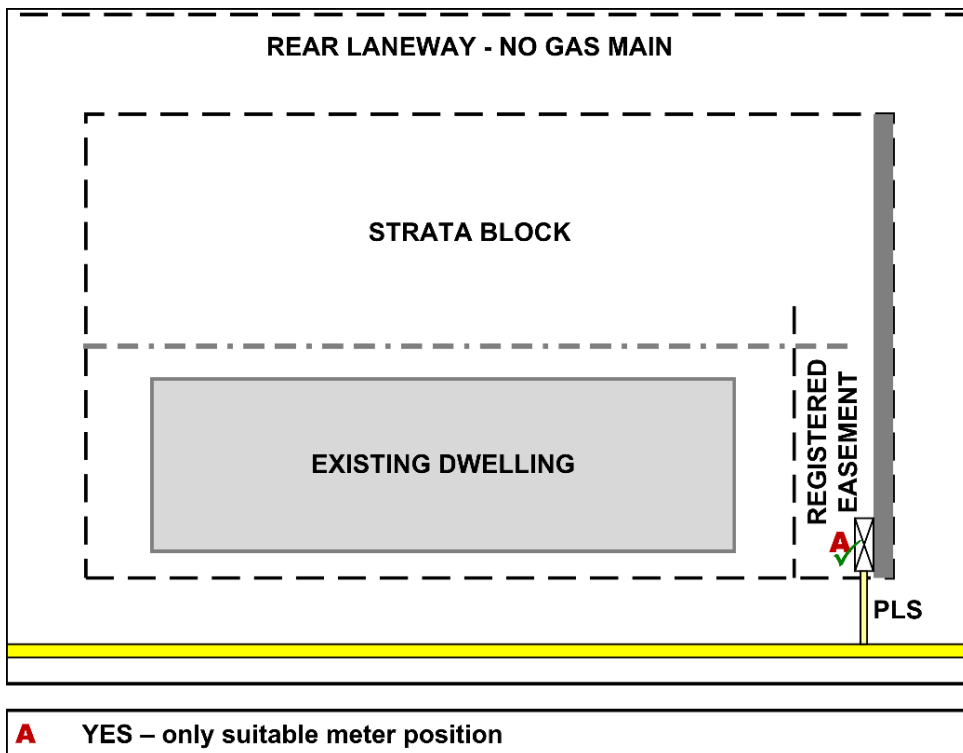

ATCO **Will Not** install a new gas service line which crosses through an adjoining lot in order to provide a service to a subdivided property, unless it falls within the alignments of the Utility Providers Code of Practice for Western Australia.



Examples of factors that may be taken into consideration by ATCO include:

- There is an existing gas service line or gas meter that requires relocation
- Written agreement has been obtained from all affected Responsible Persons in relation to the location of the service line
- In an existing strata scheme, written agreement has been obtained from all affected land owners in relation to the location of the gas service line
- Whether gas easements have been registered

#### **4.2 Location Restrictions - Consumer Meter Assemblies (AS/NZS 4645.1 - 2018)**

**Table 4** (which is an extract from AS/NZS 4645.1 - 2018) identifies prohibited and restricted locations for placement of consumer meters and internal services. Restricted locations require assessment **prior** to placement of consumer meters or internal services.

**Table 4: Consumer Meter Assemblies**

Ref	Locations	Consumer Meter Assembly	
		Prohibited	Restricted
1	A lift shaft/lift lobby/lift motor room	X	
2	In a fire control, sprinkler or hydrant pump room, fire hydrant duct, fire hose cabinets	X	
3	In/on/under a fire-isolated stairway, passageway or ramp, fire exit-way, emergency exit or other location that may prevent or obstruct egress from the building in the event of an emergency	X	
4	In a clothes chute or rubbish chute	X	
5	In a room designed for electrical metering or switchgear	X	
6	In a bedroom or sickroom or rooms designed for purpose of sleeping	X	
7	In basements or the foundation area under a building; unless contained in a dedicated enclosure/room designed to contain any potential explosions and direct their force via pressure rated ducting to a safe above ground location such that the building support structure is not compromised	X	
8	In a cavity wall, unless installed in an adequately ventilated non-combustible enclosure sealed from any adjoining recess or cavity	X	
9	Directly in contact with ground, floor or any other surface or material which may lead to corrosion of the meter or service		X
10	In a floodway or low lying areas where water may pond in contact with the meter or service		X
11	In an area of excessive vibration		X
12	In a room specifically designed to store corrosive materials	X	
13	In an area where corrosive materials may be present		X
14	In a room specifically designed to store flammable liquids or explosives materials	X	
15	Closer than <b>1.5 m</b> laterally to public or private roads without vehicular protection		X
16	In a recess or meter box not completely sealed from any adjoining recess or cavity for pressures greater than <b>7 kPa</b>	X	
17	In a recess or meter box not of adequate size to permit ease of replacement and maintenance		X
18	Near a source of ignition as described in section <b>5.6</b>	X	
19	In any unventilated position; unless relief and breather ports are vented away or breather port is small enough to be in accordance with minimum safe vent requirements	X	
20	Beneath a canopy that has the potential to accumulate gas		X
21	In any position subject to wide temperature variations		X

### 4.3 Other Gas Meter Box Location Restrictions

A gas meter box **Must Not** be installed in the following locations:

- On a fence, unless the fence is constructed of masonry  
**Note:** Local Council by-laws prohibit fixing gas meter boxes to a neighbouring boundary fence. If a gas meter is to be fixed to a neighbouring boundary wall, approval **Must** first be obtained and provided to ATCO.
- On, or recessed into, limestone walls  
**Note:** This does not apply to reconstituted limestone walls.
- In a carport or any other location where it may be struck by vehicular traffic
- In a situation where there is an obstruction to installing the gas service, maintaining or reading the gas meter or accessing the gas meter box in an emergency
- In a position where any part of the gas service to supply the gas meter box has to pass under any part of a building (i.e., house/enclosed garage slab, etc.)
- Where excavation alongside an unsupported wall or structure will compromise that wall or structure
- On the fence of, or within, a pool or spa area
- Behind fencing or a locked gate, unless no other compliant location is possible, the lock is an approved WA Services (WAS) lock, and the gas meter remains readily accessible at all times. Refer to section 3.4.1 for further details.
- In a position that contravenes the requirements of other utility service providers
- In a position where the service cannot achieve **150 mm** separation from other utilities  
**Note:** Examples of some common utilities that **Must** have a **150 mm** separation distance from the service include telecommunications, water, underground power, drains, etc. A non-compliance to the **150 mm** separation requirement is shown in **Figure 22**.

**Figure 22: Non-compliant Service Separation (Less than 150 mm)**



Ensure that the gas meter box is installed within the property boundary for the property requiring the gas connection, unless other arrangements have been accepted by ATCO in writing.

#### 4.4 Obstructions (When Gas Meter Boxes Cannot be Installed on Dwellings)

There are circumstances that may require a gas meter box to be placed at a location **other than on the dwelling** (e.g., on the property boundary). For example:

- Steep site levels (both higher than main and lower than main)
- Soil conditions that may include limestone or rock
- Tiered or terraced gardens
- Trees or dense vegetation
- Retaining walls
- On or above stairs (refer **Figure 23**).
- Other utilities in close proximity (refer section **4.3**)

**Figure 23: Gas Meter Box Installed Above Flight of Stairs (Unacceptable Positions)**



## 5. GAS METER BOX INSTALLATION REQUIREMENTS

This section provides general information on the design (dimension, ventilation, security, material) and mounting requirements which ATCO requires all gas meter boxes to meet.

### 5.1 Gas Meter Box Dimensions (Typical)

Table 5 provides typical dimensions for a metallic gas meter box.

**Table 5: Gas Meter Box Dimensions (Typical)**

Meter Box Type	Meter Application Range	Minimum Ventilation Requirement (mm <sup>2</sup> )	Width ± 2 (mm)	Height ± 2 (mm)	Depth ± 2 (mm)	Sheet Metal Minimum Thickness (mm)
Domestic	AL8-10	4800	460	505	225	0.95
Domestic (Slimline)	AL8-10	4800	460	505	210	0.95
Multi-unit	AL8-10	4800 x quantity of meters	460	430 x quantity of meters	225	0.95
Commercial	AL12-18*	7200	600	600	350	1.15

\*An AL8-10 meter may be installed into an AL12-18 meter box using a dedicated bracket which meets AL8-10 manifold requirements

### 5.2 Requirements

A gas meter box may be surface mounted or semi-recessed and **Must** satisfy the location requirements set out below.

**Note:** In all scenarios defined below, provision for securing the service riser (e.g., bolt holes drilled) **Must** be provided on the left hand side of the gas meter box prior to installation.

#### 5.2.1 AL8/AL10/AL12/AL18 Gas Meter Box – Freestanding on Legs

Gas meter box **Must** be installed in accordance with this Handbook, e.g., distance to electrical sources, openings into a building, height of meter box, clearances to power domes, etc.

- The legs **Must** be secure (poured concrete reinforcement) – please ensure the concrete is deep enough to not cause an obstruction of the gas connection (Gas Service requires **600 mm** from finished ground level)
- **Do Not** install near a power dome (unless minimum clearances are met)
- All requirements from **5.2.3, 5.2.4, 5.2.5, 5.2.6** or **5.2.7** apply in regards to clearances depending on meter size and setup
- The following requirements apply where a pre-assembled 'H' Frame is not utilised:
  - Two (2) legs Minimum per meter box
  - Galvanised steel posts can be round pipe, or square
  - Minimum **40 mm** outside diameter for AL12/AL18; **25 mm** for AL8/AL10

- Concrete **Must** be a minimum of **400 mm** below ground (to prevent becoming an obstruction to the copper service riser)
- Top of posts capped to prevent water ingress
- Meter box to be securely fastened to posts to prevent any movement

### 5.2.2 AL8/AL10/AL12/AL18 Gas Meter Box – Freestanding on Pole

Some subdivided properties such as battle-axe blocks and ‘house-behind-a-house’ scenarios require a meter box to be located at the very front boundary. This is due to narrow laneways and possible undermining of the fence line and slab of the property. If the meter box is mounted on a pole the requirements set out in this Handbook still apply.

**Figure 24: Gas Meter Box – Freestanding on Pole (Combination or Single)**



- The support pole **Must** be minimum **1.6 mm** thick and minimum of **40 mm** in diameter (square or round tubing), made of galvanised steel (coated for prevention of rust/corrosion)
- The support pole **Must** be secure (poured concrete reinforcement) – please ensure the concrete is deep enough to **Not** become an obstruction to the gas connection (gas service requires **600 mm** from finished ground level)
- **Do Not** install near a power dome (unless minimum clearances are met)
- All requirements from [5.2.3](#), [5.2.4](#), [5.2.5](#), [5.2.6](#) or [5.2.7](#) apply in regards to clearances depending on your meter size and setup

### 5.2.3 AL8/AL10 Gas Meter Box (Partially Recessed or Face-mounted)

A property with an AL8/AL10 gas meter box (partially recessed or face-mounted) is shown in **Figure 25**.

**Figure 25: AL8/AL10 Gas Meter Box**

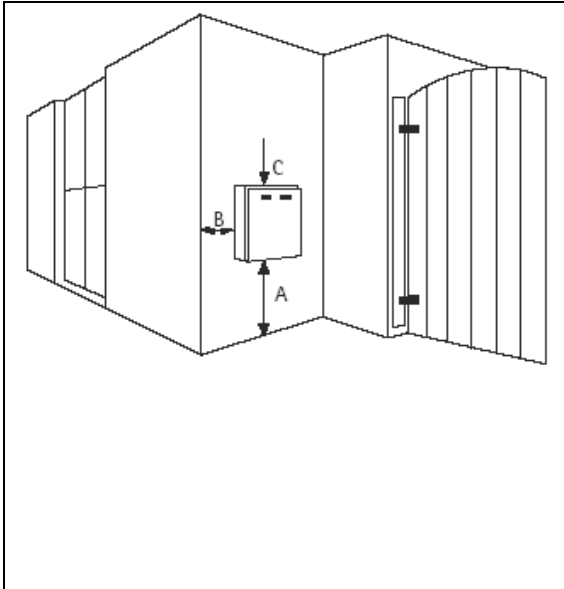

**Dimension A** – **Must** be no less than **200 mm** and no greater than **1500 mm**

**Dimension B** – Gas meter boxes **Must** be installed in a location not greater than **1000 mm** behind the Building Frontage of a dwelling

**Dimension C** – The front of the box **Must** be no less than **125 mm** from the finished surface, i.e., render. Alternatively, a recess, the full width of the gas meter box, **Must** be created underneath the gas meter box. This recess **Must** be continued below ground level to maintain ventilation to the box and access to the service.

**Caution: Do Not** obstruct ventilation openings.

### 5.2.4 AL12 Gas Meter Box (Partially Recessed or Face-mounted)

A property with an AL12 gas meter box (partially recessed or face-mounted) is shown in **Figure 26**.

**Figure 26: AL12 Gas Meter Box**

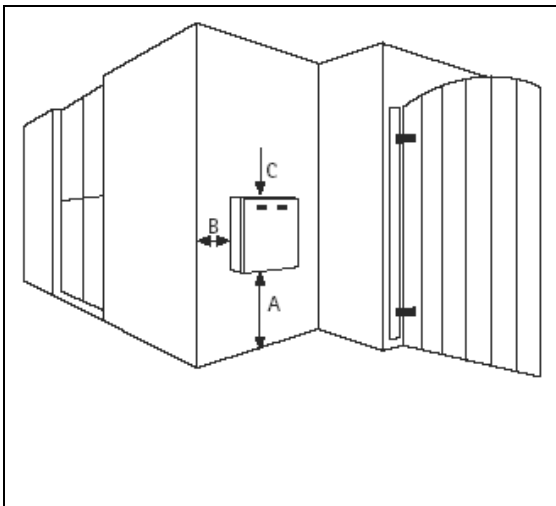

**Dimension A** – **Must** be no less than **300 mm** and no greater than **1000 mm**

**Dimension B** – **Must Not** exceed **1000 mm**

**Dimension C** – The front of the box **Must** be no less than **260 mm** from the finished surface, i.e., render. Alternatively, a recess, the full width of the gas meter box, **Must** be created underneath the gas meter box. This recess **Must** be continued below ground level to maintain ventilation to the box and access to the service.

**Caution: Do Not** obstruct ventilation openings.

### 5.2.5 AL8/AL10 Dual Gas and Electric Meter Box (Partially Recessed or Face-mounted)

A property with an AL8/AL10 dual gas and electric meter box (partially recessed or face-mounted) is shown in **Figure 27**.

**Figure 27: AL8/AL10 Dual Gas and Electric Meter Box**

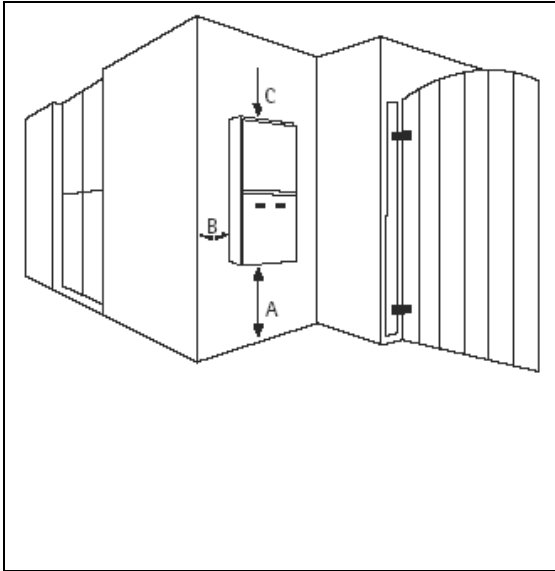

**Dimension A** – Should be no less than **600 mm** and no greater than **760 mm**

**Dimension B** – Gas meter boxes **Must** be installed in a location not greater than **1000 mm** behind the Building Frontage of a dwelling

**Dimension C** – The front of the box **Must** be no less than **125 mm** from the finished surface, i.e., render. Alternatively, a recess, the full width of the gas meter box, **Must** be created underneath the gas meter box. This recess **Must** be continued below ground level to maintain ventilation to the box and access to the service.

**Caution: Do Not** obstruct ventilation openings.

**Dual Gas and Electric Meter Boxes – Dimension A** height is set by the relevant power authority.



### 5.2.6 AL12 Dual Gas and Electric Meter Box (Partially Recessed or Face-mounted)

A property with an AL12 dual gas and electric meter box (partially recessed or face-mounted) is shown in **Figure 28**.

**Figure 28: AL12 Combined Gas and Electric Meter Box**

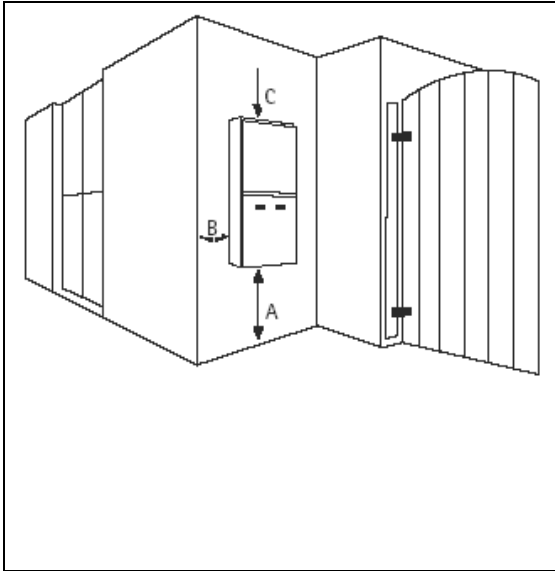

**Dimension A** – Should be no less than **600 mm** and no greater than **760 mm**

**Dimension B** – Gas meter boxes **Must** be installed in a location not greater than **1000 mm** behind the Building Frontage of a dwelling

**Dimension C** – The front of the box **Must** be no less than **260 mm** from the finished surface, i.e., render. Alternatively, a recess, the full width of the gas meter box, **Must** be created underneath the gas meter box. This recess **Must** be continued below ground level to maintain ventilation to the box and access to the service.

**Caution:** Do Not obstruct ventilation openings.

**Dual Gas and Electric Meter Boxes – Dimension A** height is set by the relevant power authority.

5.2.7 Multi-unit Gas Meter Boxes (Partially Recessed or Face-mounted)

The following provides an overview of multi-unit box installation requirements (refer **Figure 29** and **Figure 30**).

**Figure 29: AL8/AL10 Double and Triple Gas Meter Box - Dimensions**

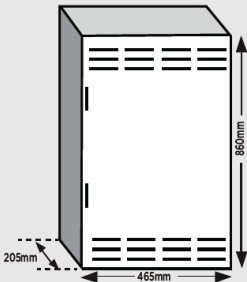
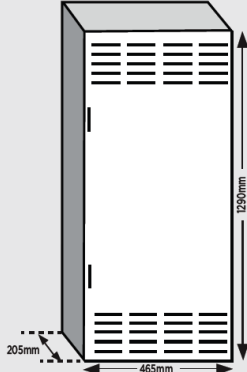
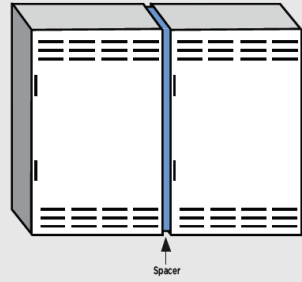
DOUBLE METER BOX:	TRIPLE METER BOX:	SPACER:
		
<ul style="list-style-type: none"> <li>• 10 course high x 2 course wide</li> <li>• Designed to suit 1200 mm high wall</li> <li>• Minimum wall height required: 1060mm high</li> </ul>	<ul style="list-style-type: none"> <li>• 15 course high x 2 course wide</li> <li>• Designed to suit 1800 mm high wall</li> <li>• Minimum wall height required: 1490mm high</li> </ul>	<ul style="list-style-type: none"> <li>• Spacer available for joining multiple meter boxes</li> <li>• Available for double and triple meter boxes</li> </ul>

**Figure 30: AL8/AL10 Double and Triple Gas Meter Box**

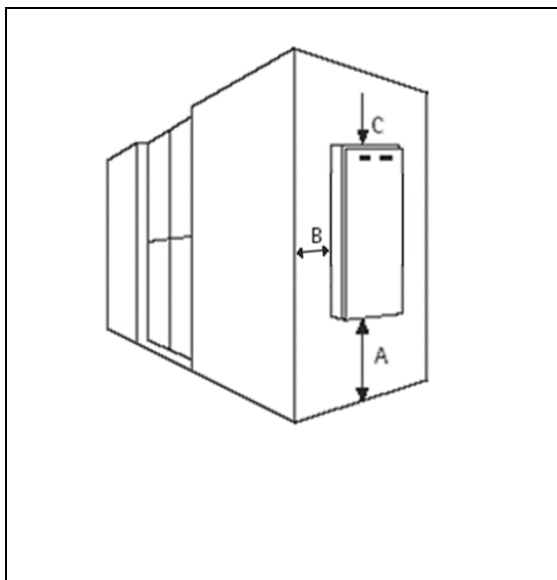

**Double or Triple Box for AL8/AL10 Meter**

**Dimension A** – Must be no less than **200 mm**

**Dimension B** – Gas meter boxes **Must** be installed in a location not greater than **1000 mm** behind the Building Frontage of a dwelling

**Dimension C** – The front of the box **Must** be no less than **125 mm** from the finished surface, i.e., render. Alternatively, a recess, the full width of the gas meter box **Must** be created underneath the gas meter box. This recess **Must** be continued below ground level to maintain ventilation to the box and access to the service.

**Caution:** Do Not obstruct ventilation openings.

## 5.2.8 Gas Meter Box (Fully Recessed)

**Figure 31: Gas Meter Box (Fully Recessed)**

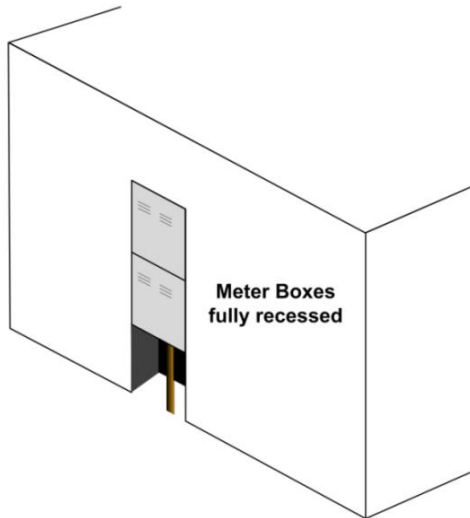

Fully recessed gas meter boxes are not recommended due to difficulties with gas service pipe connections. Specific conditions **Must** be met where failure to comply will result in delays and mandatory solutions being applied

- Gas meter box **Must Not** act as a support for brickwork
- A recess, the full width of the gas meter box, **Must** be created. This recess **Must** be continued below ground level to maintain ventilation to the box and access to the service.

**Caution: Do Not obstruct ventilation openings**

- The recess **Must** have all cavities sealed to prevent possible gas ingress
- The recess **Must** have full finish applied (i.e., render, face-brick) prior to installing gas
- No permanent panel is permitted over the recess, please refer to **Figure 32**
- Provision for securing the service riser **Must** be provided on the left hand side of the gas meter box (bolts to be installed prior to installing box)
- Separation distances **Must** be complied to (refer to **4.1.4**)



**Conforming Installation  
(Recess Sealed from Cavity)**



**Non-conforming Installation  
(Other Services Installed)**

In all locations, the gas service riser **Must Not** be sealed within a recessed wall and **Must** be left open for maintenance and ventilation. This opening **Must Not** be boarded or bricked over at any time.

The only acceptable method to cover the recess is a functioning louvered door, the door **Must** be the full size of the opening and ventilated. The inside of the recess **Must** be permanently sealed, e.g., rendered.

An approved method of covering the recess under the gas meter box, is to install a hinged, louvered door. This allows for ventilation but also allows for accessibility at all times.

Please note the following requirements:

- The door **Must** be the full width/height of the opening
- The door **Must Not** be sealed, refer to the louvered door in **Figure 32**
- The recess behind the door **Must** be permanently sealed from the cavity of the building, e.g., finished render. Refer to **5.2.8**. Other utilities are allowed in the recess as long as they meet the requirements set out in both **(4.1.4 and 5.6)**. Failure to meet this requirement will result in a delayed connection until further rectification work is completed by the Builder, Gasfitter or Owner.
- The door **Must** be installed after the gas connection is completed, this is to prevent the door (or framework) from becoming a potential obstruction
- The concrete footings **Must** be cut to allow **600 mm** penetration under the meter box position to allow the copper riser to enter at **90 degrees**

**Figure 32: Louvered Door Example for Fully Recessed Meter Box**

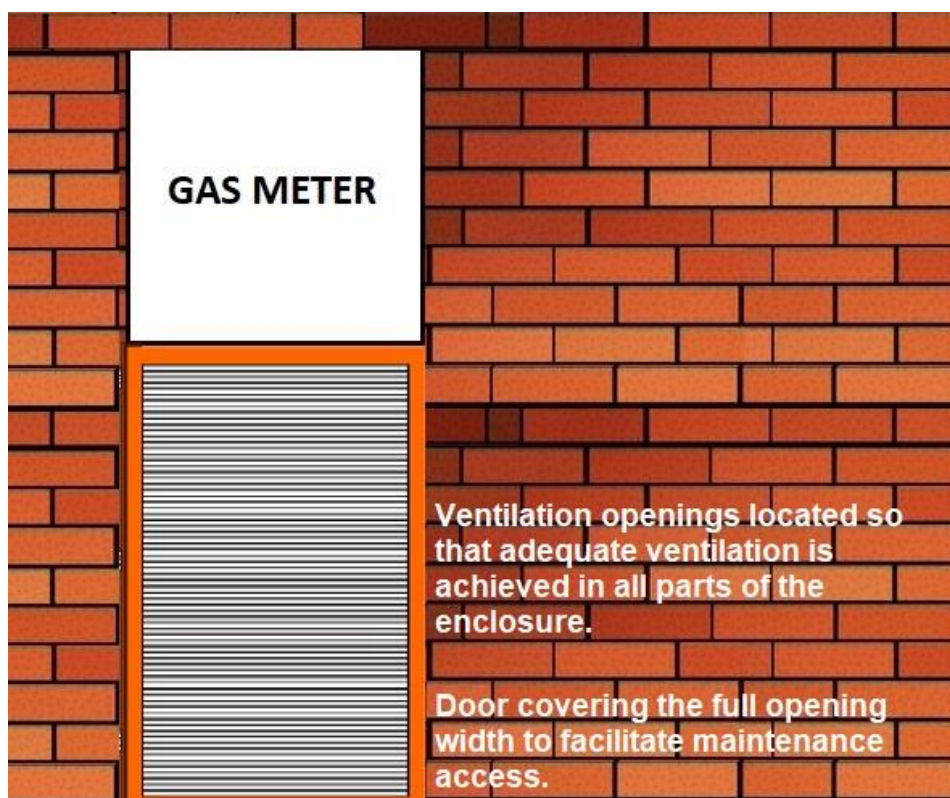

### 5.2.9 Partially Recessed Boxes (AL8/AL10/AL12)

To allow the service riser to enter the gas meter box on a partially recessed box, a channel **Must** be cut out in the brickwork that is a minimum width of **100 mm** and the wall permanently sealed to prevent any gas entering the building cavity.

- The channel **Must** be a minimum width of **100 mm** to allow for render on the inside of the channel
- “Permanently sealed” refers to a material, i.e., render, that will last the lifetime of the property. Silicone is **Not** classified as a permanent solution
- There cannot be any openings within the channel, e.g., poor rendering, holes in the brickwork, as these would provide a potential path for gas to enter the building cavity
- Allowances **Must** be made to ensure the ventilation openings under the box are not obstructed. If any vents are obstructed, the wall **Must** be rectified to clear the ventilation openings. Alternatively refer to **Figure 31** – a recess, the full width of the gas meter box, **Must** be created.
- Depth of the channel in the wall **Must** be sufficient to prevent the copper service riser from making contact with the brickwork as this will promote corrosion

**Figure 33: Partially Recessed Boxes**



Conforming Installation  
(Recess sealed from cavity, ventilation openings are not blocked)



Non-conforming Installation  
(Surface is not finished, not sealed, and cracks in the brickwork, which provide a leak path to the cavity)

## 5.3 Gas Meter Box Mounted on Walls

A gas meter box may be fixed to an exterior wall which is:

- Constructed of masonry
- Clad, providing it is suitably fixed to framework underneath the cladding

### 5.3.1 Gas Meter Boxes on Nib Walls (Recommended Alternative Gas Meter Box Position)

A nib wall (refer **Figure 34**) is a term used in construction processes for a short section of wall that protrudes at **90** degrees and adjoins the main building.

Refer to section **5.3.3** for service riser and footing requirements.

Nib walls are the preferred installation method as this avoids most compliance issues.

**Figure 34: Nib Wall (Example)**

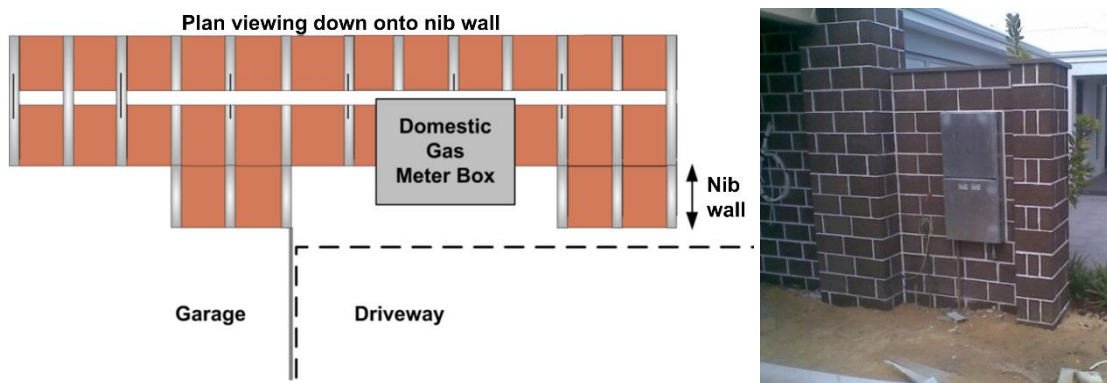

### 5.3.2 Gas Meter Boxes on Freestanding Walls

**Figure 35** shows an **example** of the level of detail required when designing and building a freestanding wall which will house a gas meter box/combination box. This level of detail is required to ensure that the wall is adequately supported. ATCO personnel are instructed **Not** to work on or near brick walls and similar infrastructure, unless information is available (and deemed sufficient) to demonstrate that the wall has been designed and built to meet these minimum requirements, or equivalent.

Refer to section **5.3.3** for service riser and footing requirements.

Where possible, freestanding walls should be avoided and nib walls used (refer to section **5.3.1**).

**Figure 35: Freestanding Wall Housing Gas Meter Box**  
*(Example/Reference Only – Not for Construction Purposes)*

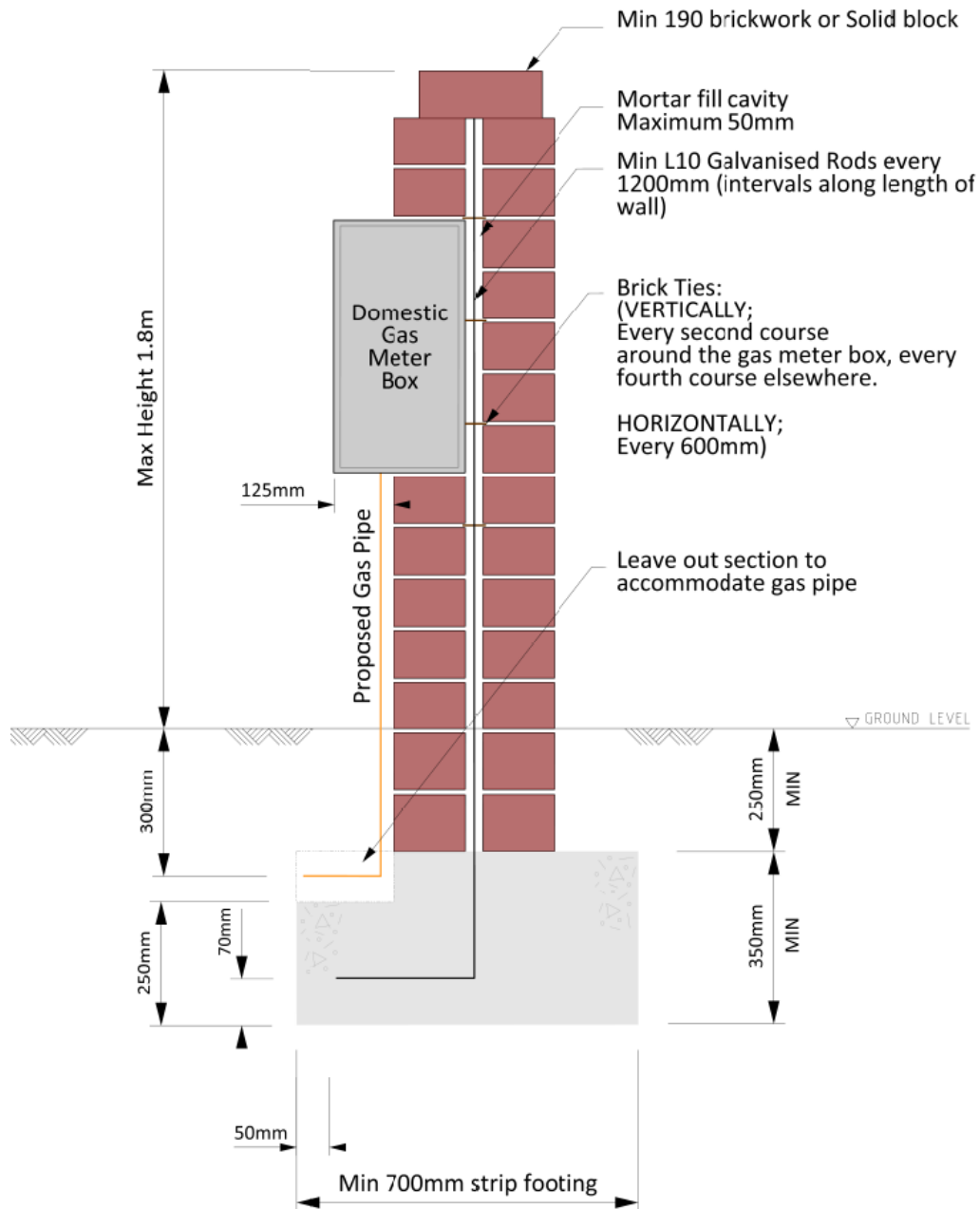

**Note:** The detail provided in **Figure 35** is the minimum requirement for freestanding walls supporting domestic gas meter boxes and **Does Not** form certified detail. The design engineer for the project is to include these requirements as a minimum but specifications should be upgraded as required to suit the particular project.

**Note:** Sub-grade **Must** be **200 mm** thick layer of clean fill compacted to minimum **96%** maximum dry density (using plate compactor).

**Note:** For the latest version refer to ATCO Drawing Office (Drawing P4-900-1655-01/02).

As noted in section 8, due care and caution should be exercised by anyone working on or in the vicinity of walls, pillars and other constructions. Safe work instructions and procedures **Must** be followed at all times.

Independent due-diligence checks and verifications should be conducted, such as obtaining advice from relevant competent engineering experts and other relevant professionals. This includes ensuring the stability, structural integrity, support, durability, performance, drainage, safety, quality, adequacy, fitness for purpose and compliance with all relevant laws, standards and codes of such constructions.

These checks apply to all constructions, including: any wall/pillar location, footings, foundations, protections, materials and any equipment, fittings, wires, cabling, pipes, conduits or apparatus (including any gas meter box) to be used, applied or installed in relation to the construction. These checks shall also be applied (as relevant) to the full lifecycle of activities, including maintenance, upkeep, repair, monitoring and checking of any such constructions on an ongoing basis.

### 5.3.3 Gas Service Riser and Footing Requirements

The minimum depth of cover for a new gas service is **600 mm** below finished ground level. In some instances, approval may be given by an ATCO representative for a depth less than **600 mm**; this is strictly on a case-by-case basis.

To allow for installation of the gas service riser, building footings should be provided with a “recess” to enable the gas service riser to be installed vertically up the wall.

If the recess is not provided, the footing will have to be cut and a small section removed by the builder, prior to the Request for Gas being submitted (refer to **Figure 36**).

In some situations, no part of the footing may be modified as it is a fundamental part of the building’s integrity (commonly referred to as “engineered footing”). In this situation alternative gas meter box locations are preferred and **Must** be agreed **prior** to installation. Specific attention **Must** be given to the line of a service installation in close proximity to load-bearing structures or piers that could compromise structural integrity.



Figure 36: Footing Recess - Cut Out

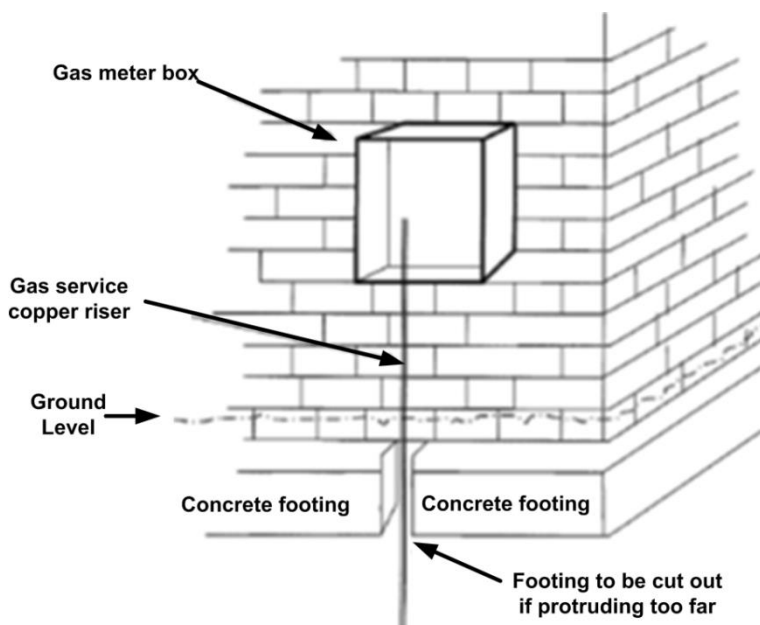

#### 5.3.3.1 Engineered Footing

The only exception to the above is when no other gas meter box location is physically possible other than one that aligns with an engineered footing. In such an instance, the following criteria **Must** be met:

- The top of the footing is a minimum of **400 mm** below ground level, allowing offset of the service riser on top of the footing. This provides adequate depth of cover to reduce interference or damage to the riser

Specific attention **Must** be given to the line of a service installation in close proximity to load-bearing structures or piers that could compromise structural integrity.

## 5.4 Locating a Gas Meter Box Away from Openings into a Building

Gas meter positions (including gas meter boxes) **Must** have a minimum clearance of **750 mm** from any door, opening window, mechanical air inlet, or any other opening into a building (refer **Figure 37**).

**Note:** Structures with roller doors, garage doors and other structures which are not habitable, are excluded from these restrictions if no other alternative is available and as approved by the ATCO Representative.

**Note:** Gas meter boxes **Must** also be located away from potential ignition sources (full details are provided in section **5.6**).

**Note:** An air brick/vent is **Not** considered an opening to a building if it is installed lower than the bottom of the gas meter box for Natural Gas installations.

Figure 37: Distances from Openings into the Building

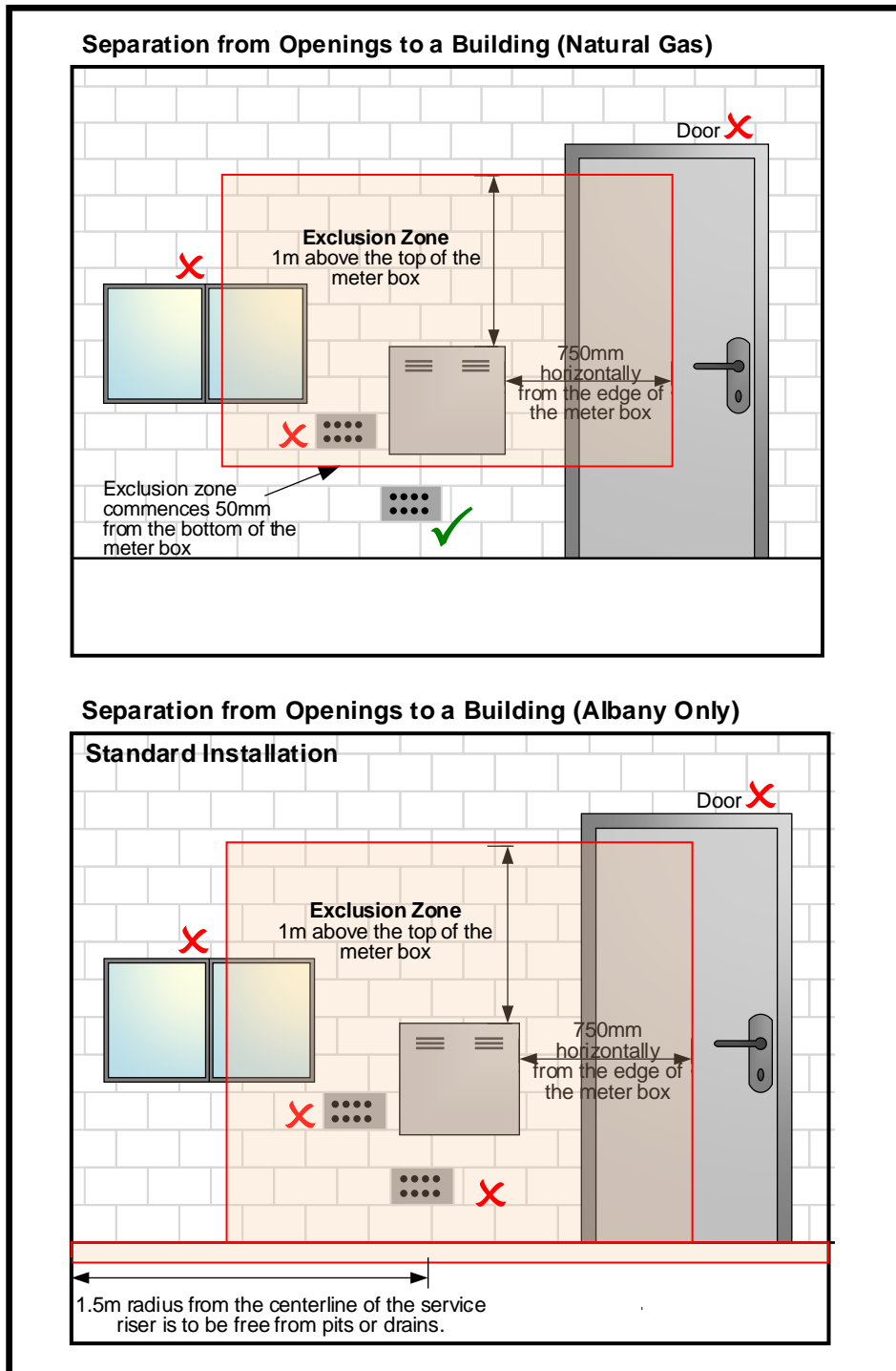

### 5.4.1 Window within Gas Meter Box Exclusion Zone

Windows within the exclusion zone **Must** be permanently fixed so they cannot open. Refer to **Figure 38**. The following methods below may resolve some compliance issues:

- Reversing the openable portion of the window (so that the fixed pane is within the exclusion zone and the openable portion is outside the exclusion zone – i.e., window shown in **Figure 38** opens on the right.)
- Permanently securing the window in the closed position with a minimum of two (2) rivets or non-retractable screws, in three (3) sides of the openable window portion. There **Must** be a minimum quantity of six (6) permanent fixtures

**Note:** Approval **Must** be obtained from ATCO before proceeding with any gas meter positions within **750 mm** of altered building windows or openings. Approval of acceptable window fixing is at ATCO's discretion.

**Figure 38: Permanently Fixing Window within Exclusion Zone**

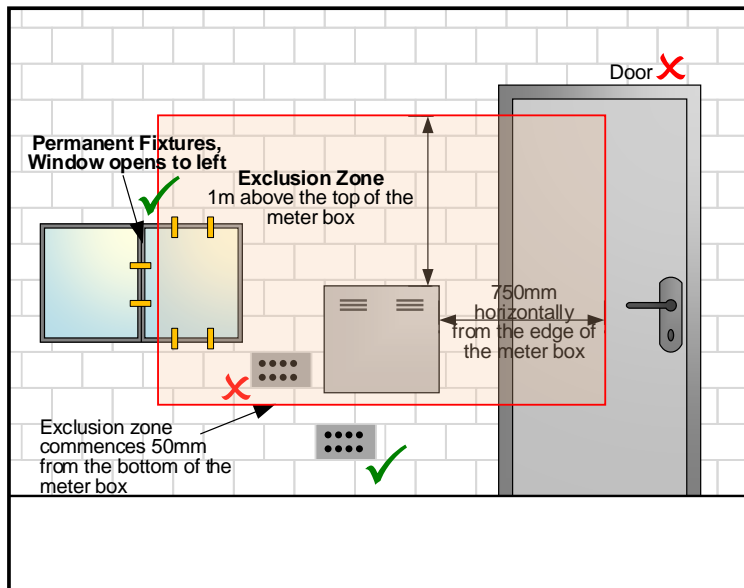

**Note:** Vent below the box is **Not** allowed in Albany (LPG Network)

5.4.2 Guidance for Measurements Around Corners to Openings

The general principle is that measurements are to be taken as the closest straight line that does not pass through obstructions, see images below.

**Figure 39: Bay Window (Measure from the window opening to the meter box, in a straight line)**

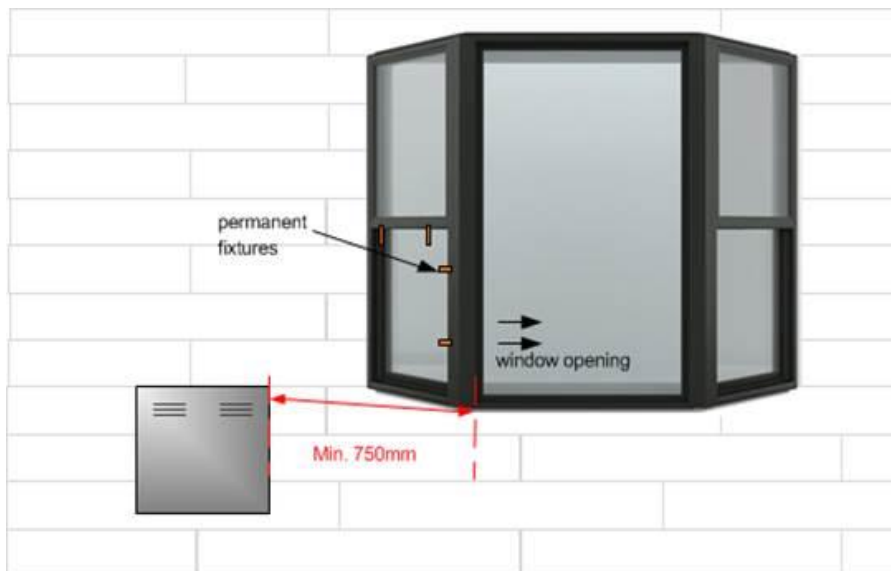

**Figure 40: Opening Around Corner (Measure from the closest opening, around the corner)**

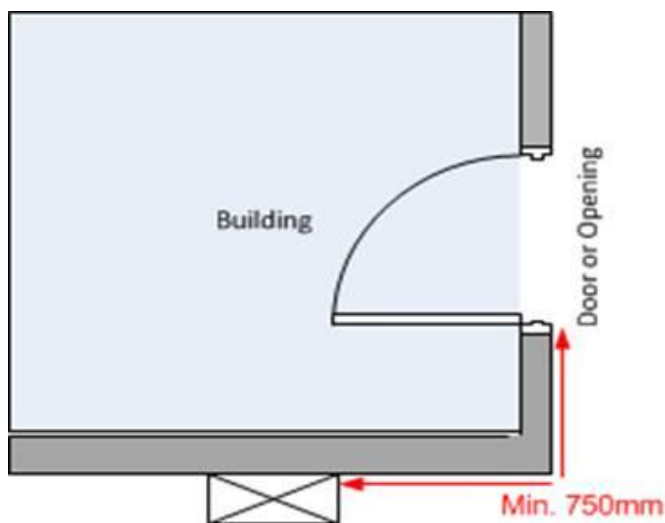

**Figure 41: Opening Around Closed Corner (Measure from the closest opening, in a straight line)**

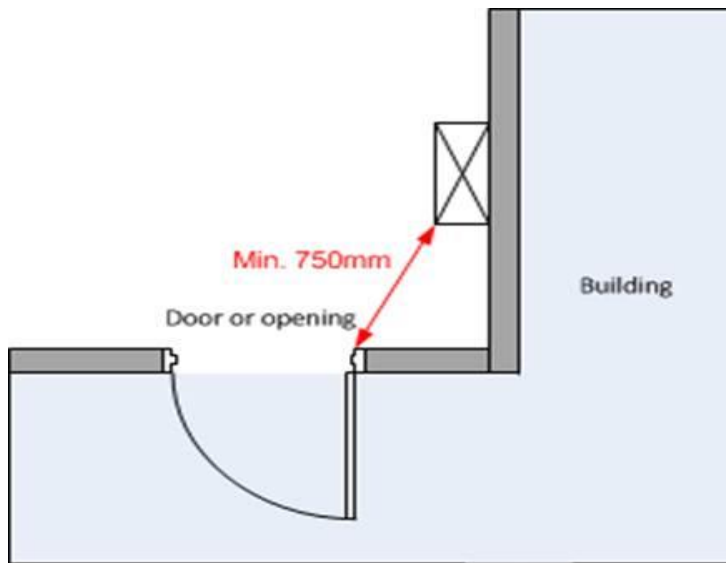

### 5.5 Gas Meter Boxes Mounted adjacent to Electrical Power Domes

A **500 mm** minimum distance exclusion zone radius (refer **Figure 42** and **Figure 43**) applies between the centre of the electrical power dome (and any associated earth electrodes) from any part of the gas installation (including the gas meter box, incoming gas service pipe, the service riser). If this cannot be achieved, written approval from Western Power, or the relevant electrical regulator, **Must** be obtained by the Builder, Customer, or Gasfitter **before** ATCO will install the gas service.

If there is a power dome in front of the gas meter box, ATCO **Will Not** connect the gas unless the clearances can be met. The Builder, Customer, or Gasfitter **Must** ensure prior to construction, that the gas meter box is located away from the power dome. Underground electrical assets also have clearance requirements, which can become an issue due to blocks of land becoming smaller.

For additional information on electrical requirements refer to the WA Distribution Connections Manual (available on the Western Power website).

**Figure 42: Distances from Electrical Power Domes**

ALL UTILITIES MUST BE OUTSIDE OF THE 1 METER (1000mm) EXCLUSION ZONE. THIS APPLIES BOTH ABOVE AND BELOW GROUND.

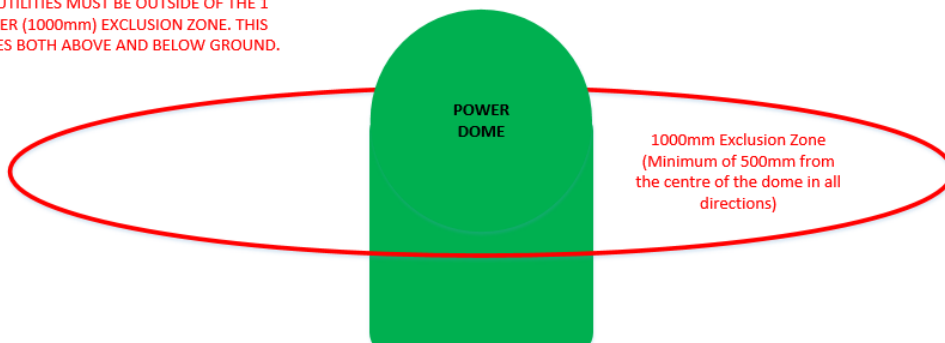

Figure 43: Distances from Electrical Power Domes (Top view)

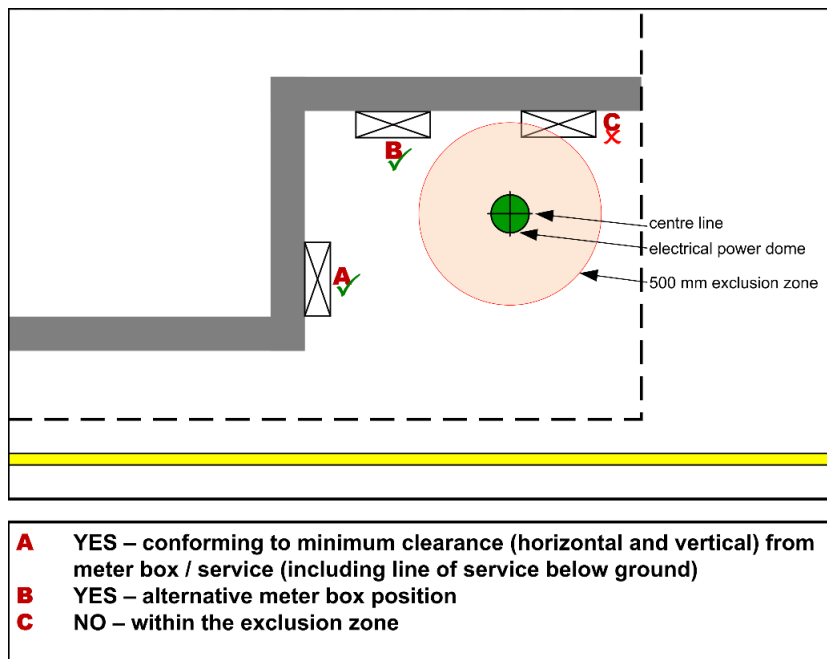
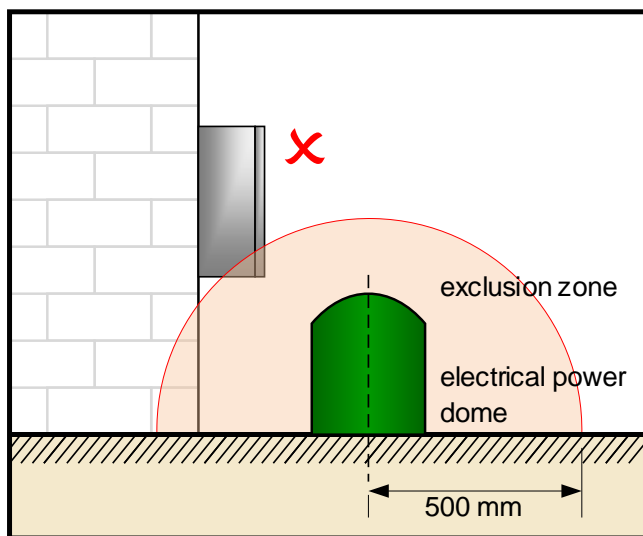

Figure 44: Distances from Electrical Power Domes (Side plan)



## 5.6 Gas Meter Boxes Mounted adjacent to Source of Ignition

A minimum of **500 mm** exclusion zone applies between any source of ignition and any part of the gas service including the service riser and gas meter box. The **500 mm** separation is required from the object containing the ignition source, e.g., air conditioning unit. The object itself **Must** remain outside of the **500 mm** exclusion zone – refer to **Figure 45**. (The only exception is a power dome, which is measured from the centre of the dome as per **Figure 43** and **Figure 44**).

A Minimum distance of **three (3) metres** is required from any gas meter box, or compound (Domestic or Commercial) to an electrical sub-station. This requirement can be reduced under certain circumstances but will need approval from an ATCO representative. Additional work may be required, such as a masonry wall, to act as separation. ATCO has assessed several common ignition sources and deemed the risk of these items to be acceptable within **500 mm** of a gas

meter box, as long as no electrical components are located inside the gas meter box. Ignition sources that have been assessed as acceptable include:

- Power outlets (weatherproof)
- Light fittings
- Telecommunication boxes (sealed)
- Reticulation controls (sealed)
- Solar inverters
- No separation distance is required between a gas meter box and a single domestic electrical meter box (if single boxes are being used instead of a combination box). Utilise a minimum of **100 mm** to allow side access to the boxes for nuts and bolts (pipework brackets)

**Note:** Gas meter boxes **Must** also be located **750 mm** away from openings into buildings (full details are provided in section 5.4).

**Figure 45: Separation from Potential Ignition Sources**

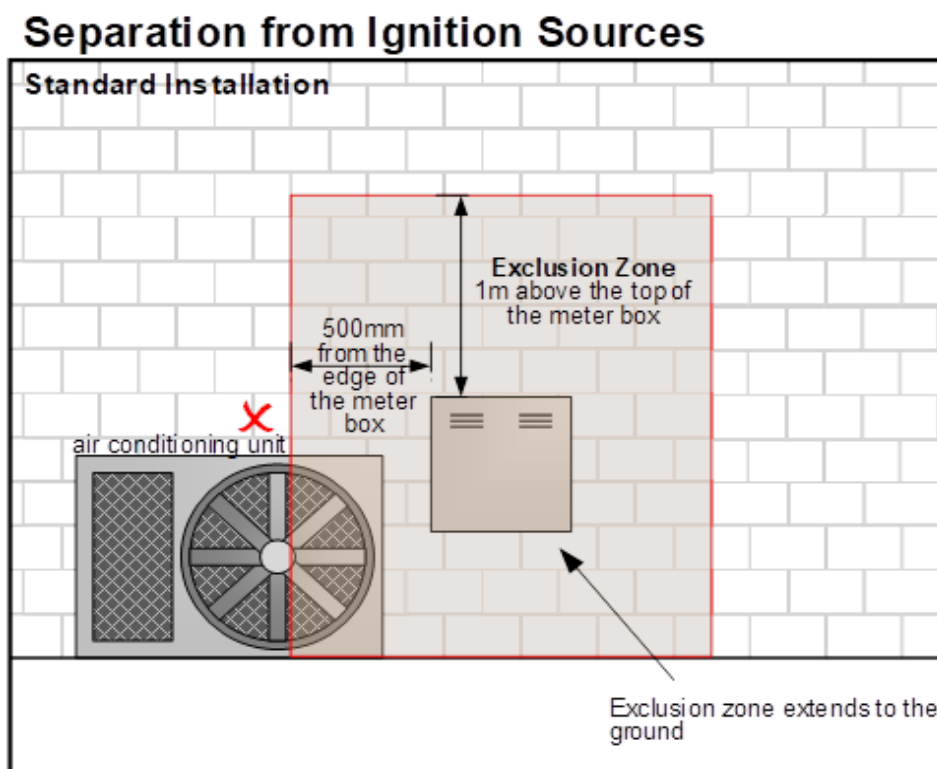

**Please Note:** Hot Water Systems **Must** be a minimum of **one (1) metre** away from any part of the gas meter box as per the AS/NZS 5601.1

## 5.7 Protection for Gas Meters

Gas meter boxes **Must** always be located away from trafficable areas to avoid impact causing uncontrolled release of gas.

If the gas meter or box is not situated in a protective recess and there is likelihood of vehicular damage (e.g., adjacent to a driveway), then the gas meter box **Must** be protected by bollards, L-brackets or alternative methods as shown in **Figure 46**, **Figure 47**, **Figure 48** and **Figure 49** below. Regardless of which protective measure is being proposed, if in doubt, please contact ATCO and provide site-specific installation details.

**Figure 46: Gas Meter Box Protection (Examples)**



**Figure 47: Gas Meter Box Protection (Bollard Diagrams)**

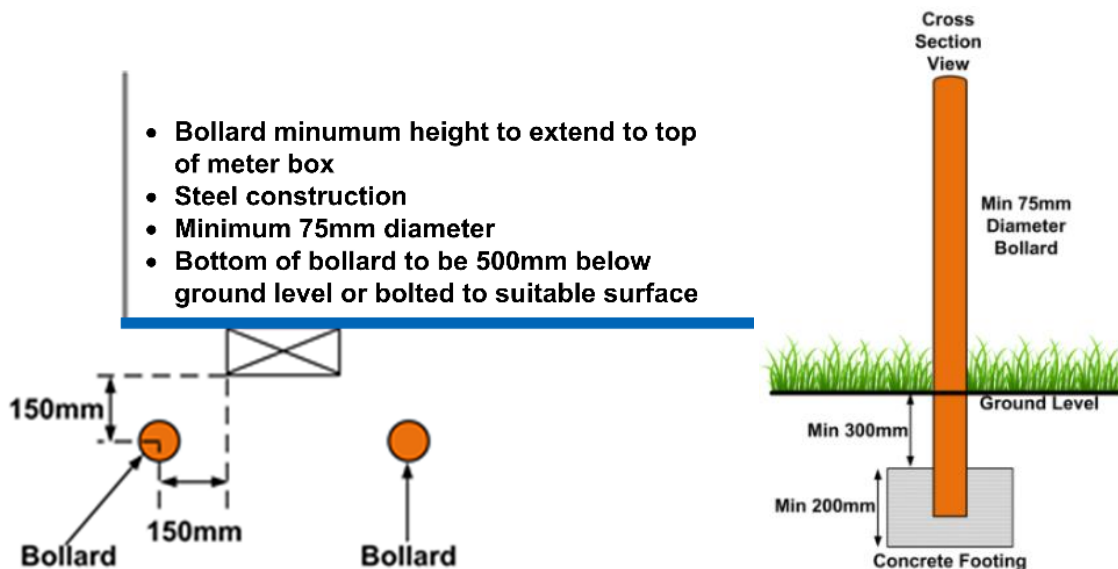

Caution should be exercised when installing bollards near existing underground utilities. **Always** call Dial Before You Dig (phone 1100) prior to any excavation works.



### 5.7.1 L-bracket Requirements

**Figure 48: Gas Meter Box Protection (L-bracket Diagrams)**

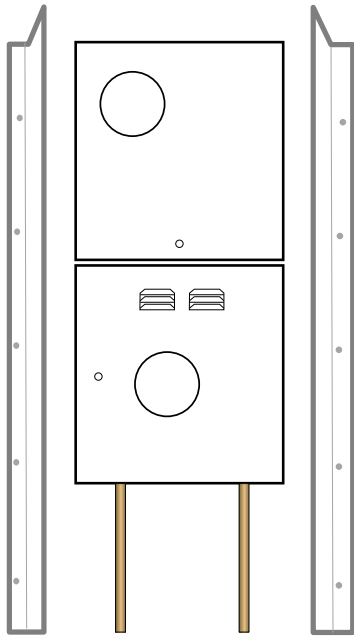

#### L-bracket Requirements:

- Protrude a minimum of **25 mm** from face of gas meter box
- **5 mm** thick minimum steel/stainless steel (can be painted to match exterior)
- Length of L-bracket **Must** be from finished ground to top of box as shown (This protects both the meter box and the pipework underneath)
- Dynabolt or heavy duty bolts to provide strength against potential vehicle impact

### 5.7.2 Vehicle Wheel Stops (Domestic Dwellings Only)

An alternative option for domestic meter box protection is to install permanently-fixed wheel stops in front of the gas meter box position; this is useful in multi-unit developments where space is limited. These are used if the gas meter box is forward facing (head-on) to a parking space, to eliminate the possibility of a head-on collision with the gas meter box and adjoining pipework.

**Figure 49: Vehicle Wheel Stops (Domestic Dwellings Only)**

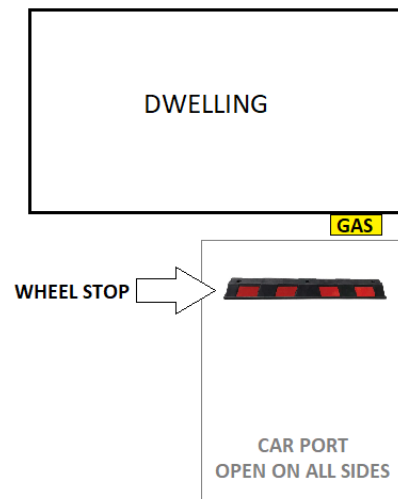

- Minimum height of wheel stop: **100 mm**
- Minimum width of wheel stop: **1700 mm**
- Minimum separation from the face of the gas meter box, to the wheel stop position: **1500 mm**

A distance of **1500 mm** from the face of the gas meter box compensates for parking of a standard utility vehicle with a towbar installed. Any approved wheel stop can be used, e.g., metal, concrete, rubber, etc.

Wheel stops can be used for **Domestic Dwellings Only**. All Commercial premises including small shops, cafés, schools, restaurants, shopping centres, etc., **Must** have bollards installed due to the longer wheel base and extended chassis for trucks. Wheel stops are **Not** approved for commercial premises. (Unless otherwise approved by an ATCO Representative).

## 6. GAS METER BANKS AND ENCLOSURES

This section provides installation guidance and restrictions that **Must** be followed when designing gas meter banks and enclosures. This may not be suitable for Combination Gas/Electric meter boxes. Refer to the relevant power authority (Western Australia Electrical Inspectors) for specific regulations.

### 6.1 Multi-unit Gas Meter Boxes

The use of specific Multi-unit Gas Meter Boxes (refer **Figure 50**) may be beneficial in the case of gas meter banks.

Double and triple gas meter boxes are available to suit various situations. For additional information, refer to section **5.2.7** and the [Multi-unit Meter Boxes Information Sheet](#) from the ATCO website.

**Figure 50: Double and Triple Gas Meter Boxes**



**Inside of Triple Box**



**Double and Triple**



**2 x Double Boxes Installed**

## 6.2 Banks of Gas Meter Boxes

When typical individual unit gas meter box positions are not available, an alternative method of connection is to install a bank of gas meters in single or numerous positions in a conforming location throughout the development (refer **Figure 51** and **Figure 52** for example configurations).

The following provides more detailed requirements for commonly encountered scenarios:

**Figure 51: AL8/AL10 Standard Gas Meter Bank Layout – Gas Meter Boxes**

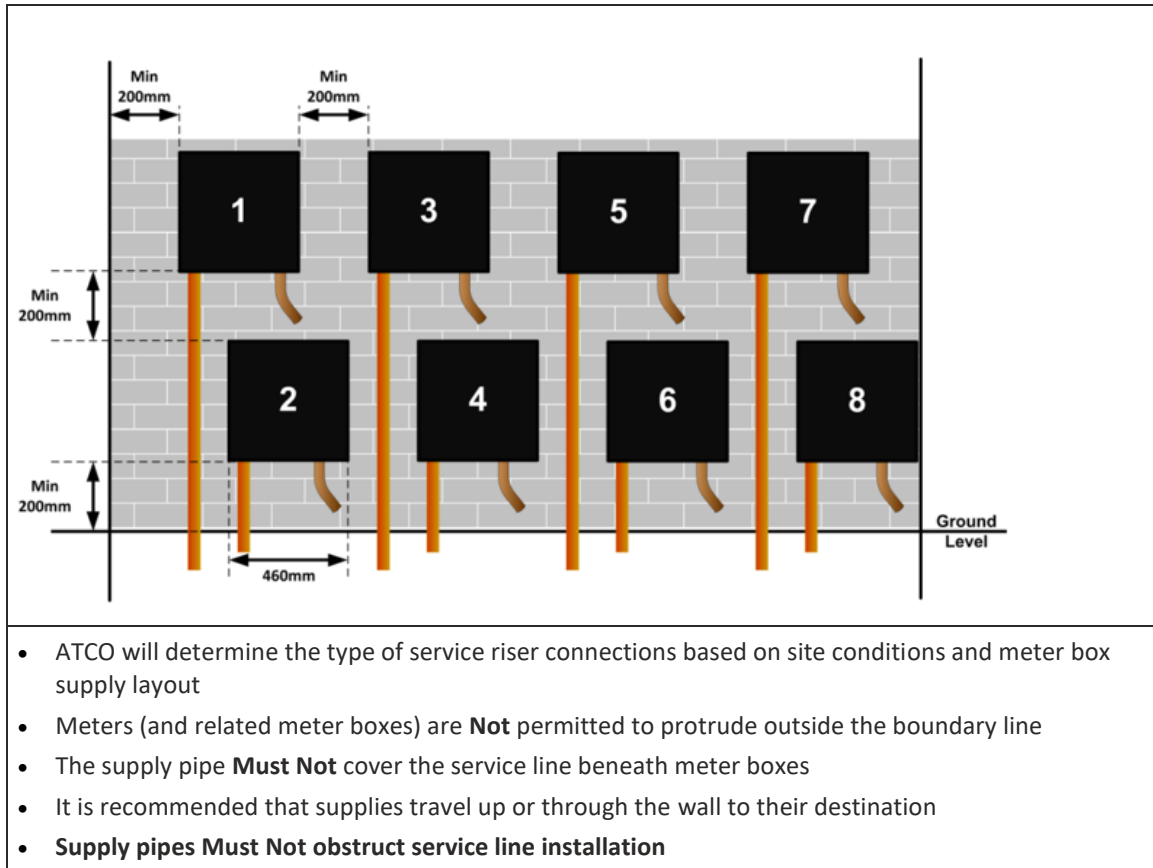
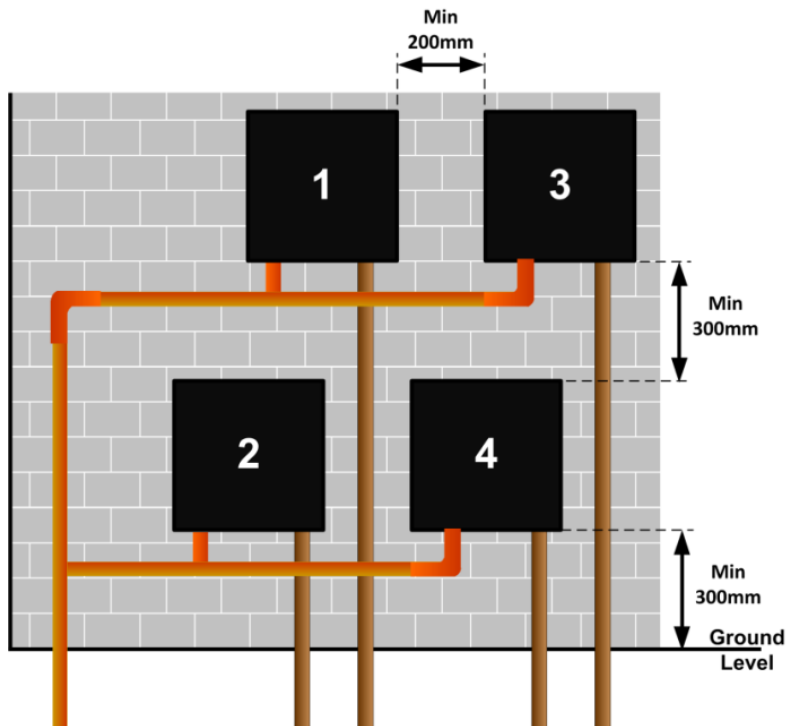

Figure 52: AL8/AL10 Non-standard Gas Meter Bank Layout – Gas Meter Boxes



Manifold connections for banks of gas meters in gas meter boxes are recommended when supply pipework cannot maintain underground separation distances from service pipework.

Gas meters may be installed in gas meter boxes on outside walls (if protected from vehicular traffic):

- Gas meter boxes **Must** be supplied and installed by the Responsible Person and mounted in accordance with dimensions as shown in **Figure 51** and **Figure 52**
- In all gas meter banks and enclosures, unit numbers are to be indicated in or on each gas meter installation (e.g., meter body) **prior** to the gas connection taking place

### 6.3 Banks of Gas Meters Mounted on ATCO Approved Brackets in Building Recesses

Enclosure width is to be determined from the number of gas meters to be situated in the enclosure (refer **Figure 53**).

**Figure 53: AL8/AL10/AL12 Gas Meter Groupings**

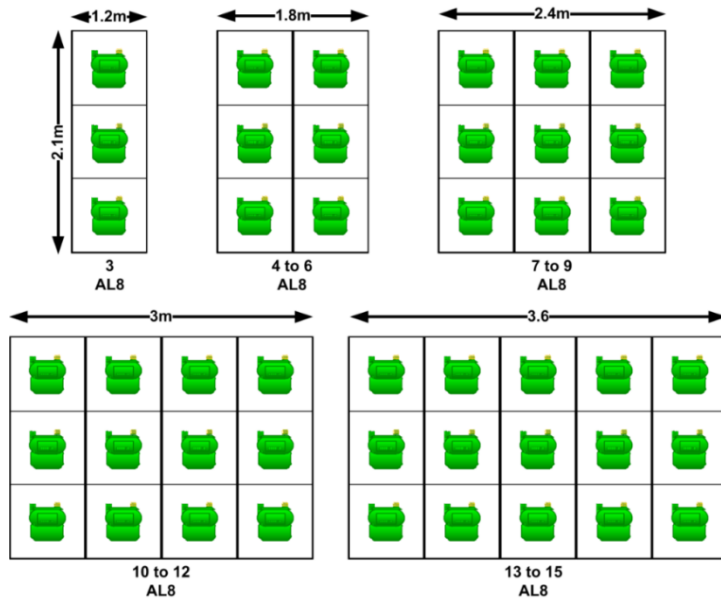

**Note:** Where multiple gas meters are installed, the Responsible Person **Must** clearly mark each gas meter box or bracket with permanent marker (or fixed and robust label) to indicate the unit number being supplied **prior** to the gas connection taking place.

**Note:** Refer to **Figure 54** for an example of an ATCO approved gas meter bracket.

**Figure 54: Gas Meter Bracket (Example)****Left:** AL8/AL10 Meter Bracket**Right:** AL12/AL18 Meter Bracket

- AL12/AL18 Brackets **Must** be installed by the Builder/Licensed Gasfitter before Request For Gas (RFG) is submitted

### 6.3.1 Depth and Height of Recesses

The depth and height of a recess **Must** meet the following criteria:

- Minimum depth of the recess is to be **600 mm**
- Height of the fully sealed recess opening is to be a Minimum of **2100 mm**
- **ATCO Engineering can review and potentially approve recesses outside of this scope**

### 6.3.2 Inside the Recess

The inside of the recess **Must** meet the following criteria:

- No electric lighting or switches may be located inside the recess or enclosure (unless electrically rated for use in such a zone, which may contain gas)
- There **Must** be unrestricted access in front of the gas meter recess

## 6.4 Gas Meters in Recesses (Enclosures)

Gas meters may be installed in banks, either in gas meter boxes or mounted on approved brackets (refer to **Figure 54**), in a recess that is ventilated to open air.

**Note:** Approval for gas meter recess location will be subject to final assessment and determination by ATCO.

The location of the recess **Must** provide clear, unhindered access to the gas meter set, provision of natural light and ventilation to the enclosure and prevent:

- Unauthorised access
- Third party damage
- Vandalism

Recesses and enclosures in a building external wall (refer **Figure 55**) **Must**:

- Provide full access to the gas service riser pipework
- Be fully sealed and constructed of materials that are of **at least two (2) hours** fire rating
- Have a secure fire retardant material seal between any openings adjoining a gas meter room attached to the main building, (which is of cavity wall construction)
- Be located on external building façade
- **Not** to be located in a location as per **Table 4**
- **Not** to be used for storage of any other materials or chemicals

**Figure 55: Acceptable Recess or Enclosure**

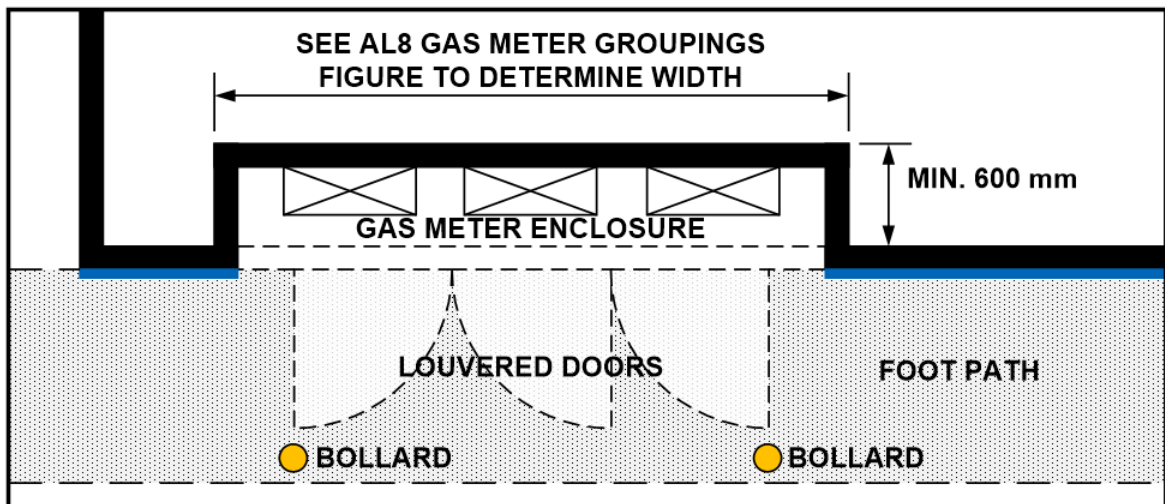

**Note:** There **Must** be **one (1) metre** of unrestricted space in front of gas meter recess and the edge of the recess **Must** be **750 mm** away from an opening into a building.

## 6.5 Doors and Ventilation

If a recess is to have doors fitted (to prevent unauthorised access) then the recess (refer **Figure 56**) **Must** have:

- Doors covering the full opening width to facilitate maintenance access
- Doors constructed of fire-retardant material
- Direct and adequate ventilation to outside atmosphere – maximum ventilation **Must** be achieved, preferably by the use of appropriately-sized high and low ventilation to outside atmosphere to achieve air circulation
- Ventilation openings located so that adequate ventilation is achieved in all parts of the enclosure (i.e., from floor to roof level)
- Appropriate signage on the outside to indicate gas meters are located inside, as determined in consultation with ATCO

**Figure 56: Recess or Enclosure with Fully Louvered Doors (Examples)**

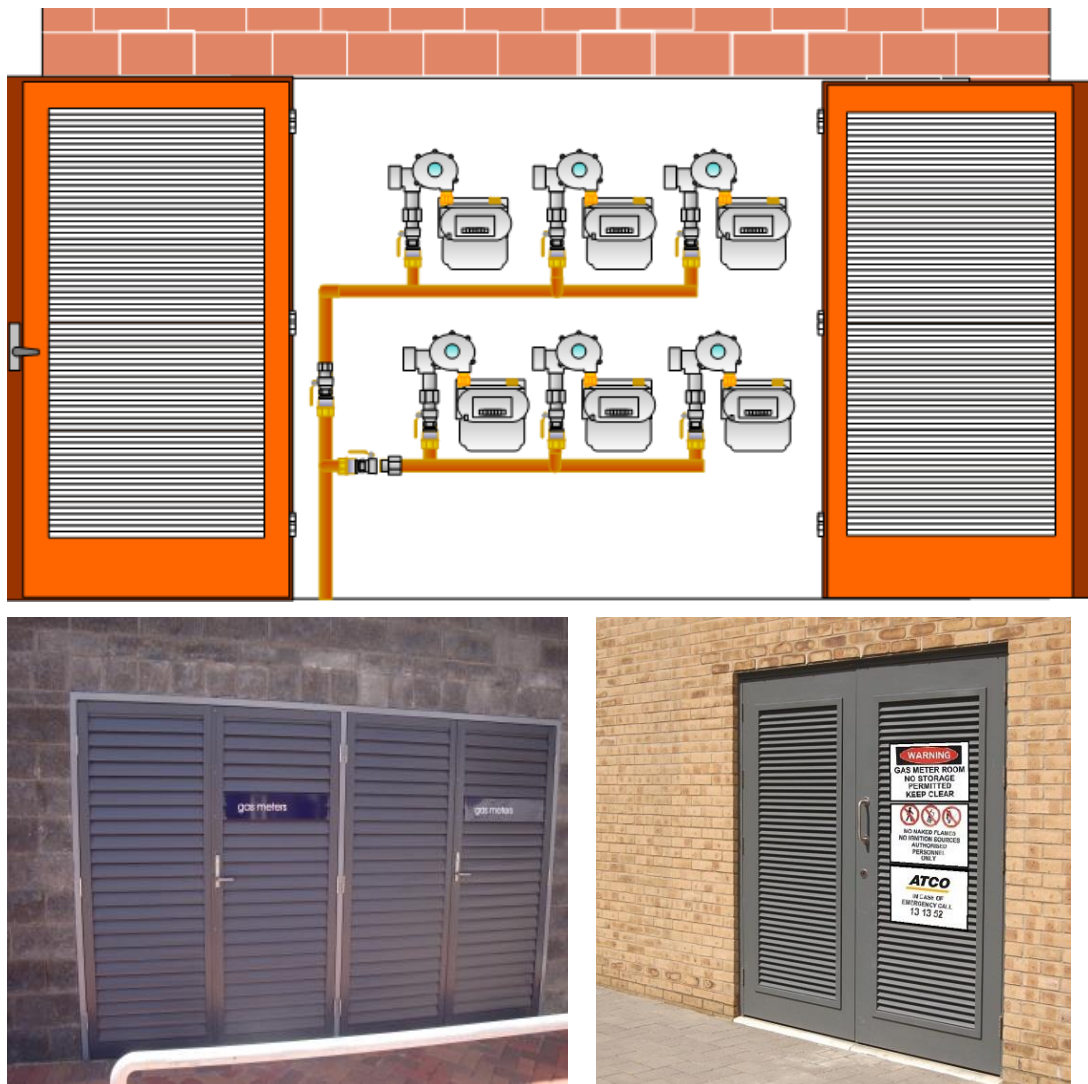



## 6.6 Floor Finishes

Floor finishes **Must** be of **15 mm** blue metal (minimum **100 mm** thick) over plastic sheeting, except where the gas meter set is located in a position where the floor of the recess is part of the building. In this case, the gas meter riser **Must** be installed in a manner that will provide future access to the gas service riser pipework **both above and below ground**.

## 6.7 Security Access

All gas meter enclosures **Must** have approved Western Australian Services (WAS) locks installed for maintenance and emergency access. For more information refer to section **3.4.1**.

## 6.8 Signage

Recesses enclosed with doors **Must** have appropriate signage on the outside to indicate gas meters are located inside.

**Note:** Where access to the meter room is only possible from inside the main building, a sealed door **Must** be fitted with an automatic closing mechanism, draught strip and clearly visible signage stating 'GAS METER ROOM, Restricted area—no source of ignition' or equivalent signage as determined in consultation with ATCO. Refer to **Figure 57** for an example of signage on a meter room door.

**Figure 57: Meter Room – Example of Signage**



The following signs are **Mandatory** on each enclosure entry:

- a) P4-900-1236-05 - Danger Flammable Natural Gas **450 mm x 300 mm**
- b) P4-900-1236-06 - No Naked Flames, No Ignition Sources Authorized Personnel Only **450 mm x 300 mm**
- c) P4-900-1236-07 - ATCO In Case of Emergency Call 13 13 52 **450 mm x 300 mm**

## 7. RELATED DOCUMENTS

The following ATCO documentation **Must** be referred to when positioning gas meter boxes:

### ATCO Documents Referenced

- ATCO Policies, Procedures and SWI's (available upon request)
- [Connection Process Handbook](#)
- [Multi-unit Meter Boxes Information Sheet](#)
- [AGA-A&C-GL05 Residential Unit Development Handbook](#)

The following Standards and Legislation **Must** also be referred to when positioning gas meter boxes:

### Standards and Legislation

- AS/NZS 4645.1 Gas Distribution Networks, Part 1 – Network Management
- AS/NZS 4645.1 Gas Distribution Networks, Appendix K – Consumer Billing Meters
- AS/NZS 4130 Polyethylene (PE) Pipes for Pressure Applications
- AS/NZS 5601.1 Gas Installations
- British Standard BS-6400-1
- Energy Coordination Act 1994
- Environmental Protection Act 1986
- Gas Standard Act 1972
- Gas Standards [Gas Fitting and Consumer Gas Installations] Regulations 1999
- Gas Standards [Gas Supply and System Safety] Regulations 2000
- Occupational Safety and Health Act 1984
- Occupational Safety and Health Regulations 1996
- Utility Providers Code of Practice for Western Australia (Orange book)
- Western Australia Excavation Code of Practice 2005

### ATCO Related Documents (for additional information)

- [Gas Connection Checklist](#)
- [AGA-SWI-CO31-FM01 Gas Service Installation - ON HOLD Form](#)
- [Gas Safety – DOs and DON'Ts](#)
- [Feedback Form – GMBLH RUDH](#)

## 8. DISCLAIMER

1. Information provided in this document relates only to installation of ATCO's infrastructure and does not relate to installation of other utility services.
2. Diagrams provided in this document cannot be used to ensure the stability, structural integrity, support, durability, performance, drainage, safety, quality, adequacy, fitness for purpose or compliance with any law, standard or code of any wall, pillar or other construction or its location, footings, foundations, protections, materials or any equipment, fittings, wires, cabling, pipes, conduits or apparatus (including any gas meter box) used, applied or installed in relation to any construction.
3. The diagrams and drawings provided are not to scale. Due care and caution should be exercised by anyone working on or near walls, pillars and other constructions. Safe work instructions (SWI's) and procedures should be followed at all times.
4. To the maximum extent allowed by law, no warranty or representation is given or made concerning the diagrams provided in this document (including as to quality, completeness, accuracy or fitness for any purpose or that it complies with any applicable laws, standards or codes).
5. You should conduct your own independent due diligence checks and verifications and obtain your own independent design and advice from relevant competent engineering experts and other professionals (including to ensure the stability, structural integrity, support, durability, performance, drainage, safety, quality, adequacy, fitness for any purpose and compliance with all relevant laws, standards and codes) for your own constructions (including for any wall or pillar), their location, footings, foundations, protections, materials and any equipment, fittings, wires, cabling, pipes, conduits or apparatus (including any gas meter box) to be used, applied or installed in relation to those constructions; and for the maintenance, upkeep, repair, monitoring and checking on an ongoing basis of any such constructions.
6. To the maximum extent allowed by law, ATCO, its related bodies corporate and officers, employees, agents or contractors are not liable in any way whatsoever (including for negligence, recklessness or breach of any statutory duty) for any loss, liability, cost or claim of any kind whatsoever (including any direct loss, indirect loss, consequential loss, economic loss, loss of profit, loss of opportunity, death, illness, injury or damage to reputation or goodwill) arising from or in relation to the use of, or reliance on, diagrams in this document.
7. ATCO reserves the right at any time (without giving any notice) to modify, supplement or withdraw diagrams or any other part of this document.
8. In this document, 'including' means 'including, but not limited to'. Reference to 'this diagram' includes any part of it (including any information or drawing in it).
9. ATCO owns the copyright in the diagram referred to as **Figure 35** and does not give any license to copy or reproduce this diagram.
10. This Disclaimer may not be altered, omitted, hidden or removed, except by ATCO.
11. Whilst every care has been taken to ensure the accuracy of this information at the time of publication, the information is intended as guidance only. It should **Not** be considered as legal advice.

## 9. APPENDICES

The Appendices contain printable forms, checklists and other information referred to throughout this document.

List of Appendices	
<a href="#">Appendix A</a>	Gas Connection Checklist
<a href="#">Appendix B</a>	Gas Service Installation - On Hold Form
<a href="#">Appendix C</a>	Gas Safety – DOs and DON'Ts
<a href="#">Appendix D</a>	Feedback Form – GMBLH_RUDH

**APPENDIX A. GAS CONNECTION CHECKLIST**



**GAS CONNECTION CHECKLIST**  
GAS DIVISION

Gas Connection Checklist	Yes	No
Have you referred to the ATCO Gas Meter Box Location Handbook?	<input type="checkbox"/>	<input type="checkbox"/>
Have you referred to the ATCO Residential Unit Development Handbook?	<input type="checkbox"/>	<input type="checkbox"/>
Has gas availability been confirmed?	<input type="checkbox"/>	<input type="checkbox"/>
If Yes, where?	<input type="checkbox"/>	<input type="checkbox"/>
Is the correct gas meter box fitted?	<input type="checkbox"/>	<input type="checkbox"/>
Is gas meter box at the correct recess depth?	<input type="checkbox"/>	<input type="checkbox"/>
If not, has fully recessed box guide been followed?	<input type="checkbox"/>	<input type="checkbox"/>
Has gas meter box been positioned within <b>1000 mm</b> of the Building Frontage?	<input type="checkbox"/>	<input type="checkbox"/>
Does the gas meter box require bollard protection?	<input type="checkbox"/>	<input type="checkbox"/>
Is the gas meter box <b>750 mm</b> (or more) from opening doors and windows?	<input type="checkbox"/>	<input type="checkbox"/>
Is the gas meter box <b>500 mm</b> (or more) from any source of ignition?	<input type="checkbox"/>	<input type="checkbox"/>
Has channel been cut in footings where required? <b>SEE "Freestanding Wall" and "Footing Recess" OVERLEAF</b>	<input type="checkbox"/>	<input type="checkbox"/>
Is site clear between gas meter box and gas connection (i.e., is sand, rubbish and/or building material blocking access?)	<input type="checkbox"/>	<input type="checkbox"/>
Is a temporary power pole obstructing access to the gas meter box?	<input type="checkbox"/>	<input type="checkbox"/>
Check to ensure that no reinstatement paving has been laid (i.e., driveway under gas meter box)	<input type="checkbox"/>	<input type="checkbox"/>
If a combination gas meter box – does the installation comply with electrical requirements?	<input type="checkbox"/>	<input type="checkbox"/>

Comments

**Freestanding Wall Housing Gas Meter Box (Example/Reference Only – Not for Construction Purposes) – Excerpt from GMBL Handbook (See Table of Contents)**

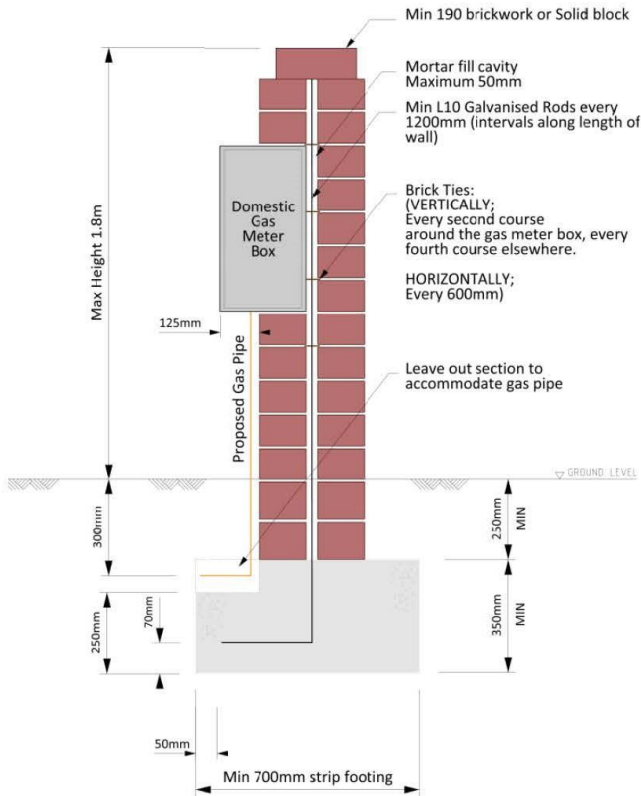

**Note:** The detail provided in this drawing is the minimum requirement for freestanding walls supporting domestic gas meter boxes and **Does Not** form certified detail. The design engineer for the project is to include these requirements as a minimum but specifications should be upgraded as required to suit the particular project.

**Note:** Sub-grade **Must** be 200 mm thick layer of clean fill compacted to minimum 96% maximum dry density (using plate compactor).

**Note:** For the latest version refer to ATCO Drawing Office (Drawing P4-900-1655-01/02).

**Footing Recess - Cut Out - Excerpt from GMBL Handbook (See Table of Contents)**

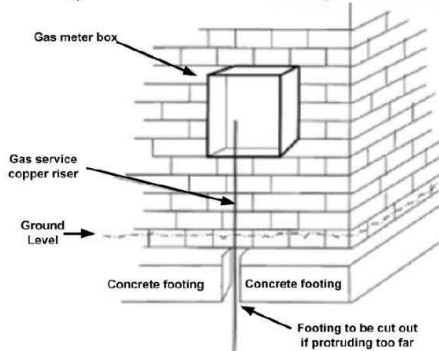

## APPENDIX B. GAS SERVICE INSTALLATION ON HOLD FORM

**CONSTRUCTION: GAS SERVICE INSTALLATION - ON HOLD**  
 GAS DIVISION

**Your Gas Service Installation Has Been Put  
ON HOLD**

An ATCO Gas Australia Service Laying contractor visited this site to connect the new gas service.

ATCO Gas Australia Job Notification No.:		Date: (dd/mm/yyyy)	
Address:			

<input type="checkbox"/>	This service line is to be connected to the gas pre-laid service (PLS), adjacent to the water meter
<input type="checkbox"/>	Connected in a straight line out to the boundary
<input type="checkbox"/>	The gas service <b>Must</b> be installed before the driveway and cross-over are installed
<input type="checkbox"/>	The gas pre-laid service is under the stairs (PLSS), terminating at the top of the stairs

Your gas service installation from the street to the gas meter box has been put ON HOLD because:	
<input type="checkbox"/>	This is a Designated Hard Dig Area: the gas meter box <b>Must</b> be installed on boundary or an open trench provided
<input type="checkbox"/>	There are building materials, etc., on the line of service
<input type="checkbox"/>	Scaffolding is in the way
<input type="checkbox"/>	The gas meter box is in a non-complying position
<input type="checkbox"/>	Gas meter box is recessed too far
<input type="checkbox"/>	Gas meter box set too high/low
<input type="checkbox"/>	Footings protrude too far. An individual channel needs to be cut in the footing under gas meter box to allow for the riser to pass through ( <b>Refer to "Freestanding Wall" overleaf</b> )
<input type="checkbox"/>	Permission is required to remove paving under the gas meter box The section at the bottom of this form can be used to grant permission to lift paving or break out concrete. <b>Please sign and leave in gas meter box.</b> <i>Please note: it is the builder's or owner's responsibility to replace any paving under the gas meter box or driveway that may have to be lifted</i>
<input type="checkbox"/>	Other: (state reason)

When the above conditions have been rectified, and to reschedule the gas service installation:
Please contact _____ (contractor mobile phone) between <b>8 am</b> and <b>4 pm</b> or the ATCO Gas Australia Contact Centre on <b>13 13 56</b> between <b>7 am</b> and <b>6 pm</b> and quote the address, job notification number and the reason (on this form) that was given for the service being put on hold. <b>Note:</b> DBYD (Dial Before You Dig) plans may need to be re-applied for. <b>Allow 7 to 10 days</b> for the installation of the gas service from the date of contact to re-schedule the gas service installation. Line of service route to remain free from obstruction for this period

Permission to Remove Paved Surface under Gas Meter Box:
I (print name in full) _____ grant permission to the above request and take responsibility for repairs and reinstatements required in the installation of the gas service
Signature: _____ Date: (dd/mm/yyyy) _____

**Note:** For full details on ATCO requirements, refer to [AGA-A&C-MA03 Gas Meter Box Location Handbook](#).

**Freestanding-Wall-Housing-Gas-Meter-Box** → *(Example/Reference-Only—Not-for-Construction-Purposes)—*  
**Excerpt-from-GMBL-Handbook-(See-Table-of-Contents)¶**

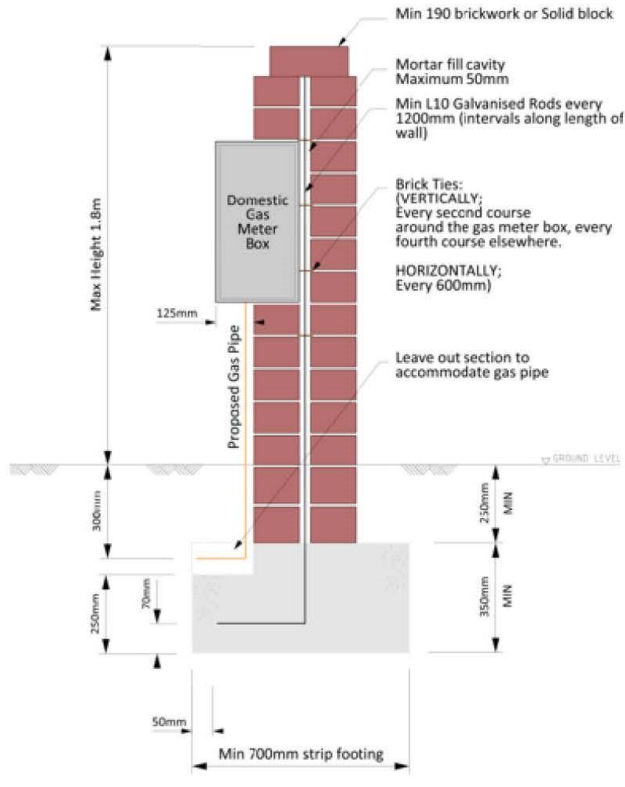

**Note:** → The detail provided in this drawing is the minimum requirement for freestanding walls supporting domestic gas meter boxes and **Does Not** form certified detail. The design engineer for the project is to include these requirements as a minimum but specifications should be upgraded as required to suit the particular project.¶

**Note:** → Sub-grade Must be 200mm thick layer of clean fill compacted to minimum 96% maximum dry density (using plate compactor).¶

**Note:** → For the latest version refer to ATCO Drawing Office (Drawing: P4-900-1655-01/02).¶

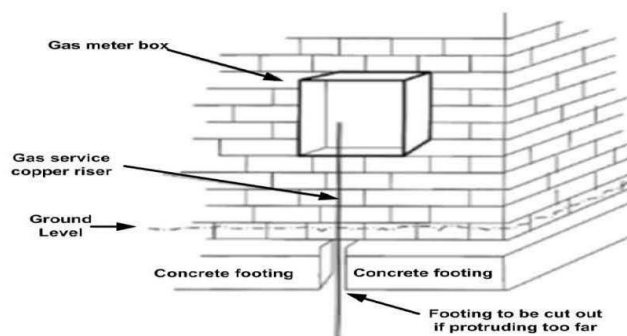



## APPENDIX C. GAS SAFETY – DOS AND DON'TS

**GAS SAFETY - DOS AND DON'TS**  
 GAS DIVISION

**When you HEAR, SEE or SMELL Gas  
or when you have DAMAGED a Gas Asset**
**DOs**

- Hear – See – Smell Gas – **STOP!**  
Immediately move to a safe location upwind
- Broken Gas Service or Gas Main – **STOP!**  
Immediately move to a safe location upwind
- If gas is smelled inside – **STOP! Open** doors and windows to allow gas to dissipate. Stay outside
- If gas is smelled outside – **STOP! Close** doors and windows and turn off air conditioners to prevent gas entering the building. Stay inside
- **Contact 13 13 52 immediately (from a safe location)**

**DON'Ts**

- Enter a gas cloud or gaseous atmosphere
- Attempt to stop the gas
- Turn on or off anything electrical
- Allow anyone to smoke near the gas leak
- Use a mobile phone in close vicinity to a gas leak
- Delay in contacting **13 13 52**

